

Steele
RUBBER PRODUCTS®

Quality Crafted Rubber Seals and Parts

RV Weatherstripping Catalog

- Slide Out Seals
- Door Seals
- Compartment Seals
- Window Seals
- Insert Trim
- Vintage Trailers & More



Toll Free 800-230-5897
STEELERUBBER.COM



THIS IS YOUR RV CATALOG

Thank you for trusting Steele Rubber Products with the protection of your recreational vehicle.

Here at Steele Rubber Products, we've been making quality crafted rubber parts and weatherstripping since 1958. We're a family run business now in its third generation and we continue to proudly manufacture in the United States!

Our goal is to provide you the best quality and fitting seals and weatherstripping available on the market. Learn more about us and everything we offer by visiting our website at steelerubber.com.

HOW TO USE THIS CATALOG

We've done a lot of research to make this catalog easy to use and it's designed to help you find what parts you need. Grouped into specific categories, each part is presented with a profile silhouette and exact dimensions to help you identify the correct shape and size, ensuring the best fit.

We are so determined in finding you the best solution, we even offer samples of our seals before you make the decision to buy.

If at any time you need assistance, our team of Product Specialists are here to help.



HOW TO ORDER

GO TO STEELERUBBER.COM

SEARCH FOR
PART NUMBER

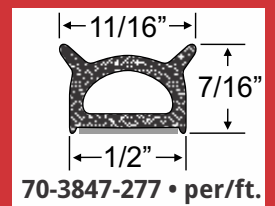

OR CALL

800-230-5897

8am-6pm Eastern

CONTACT US

EMAIL

rv@steelerubber.com

MAIL

6180 E NC 150 HWY
DENVER, NC 28037



RV WEATHERSTRIPPING

- **WINDOW SEALS**
 - STATIONARY GLASS CHANNEL 2
 - SLIDING GLASS CHANNEL 3
 - WINDOW GLAZING & TRIM 4
 - SWING OUT GLASS 5
- **DOOR SEALS**
 - ACCESS DOORS & COMPARTMENT DOORS .. 6
- **DRIP RAIL/INSERT & BODY TRIM** 9
- **SLIDE-OUT SEALS**
 - PRESS IN TRACK SEAL10
 - WIPER & BULB 11
 - ONE PIECE & SECONDARY SEALS 12
 - WIPER WITH TRACK 12
 - SLIDE-OUT FLIPPER BUMPER SET 13
 - SLIDE-OUT "H" SEAL REPAIR 13
- **RAMP-GATE KITS**..... 14
- **HATCHES** 15
- **ROOF MOUNTED A/C, HEAT-PUMP GASKET** ..16
- **VINTAGE TRAILER SEALS** 17
- **CAMPER TOP & TONNEAU COVER SEALS** ..18
- **ROOF RACK INSERT STRIPS**18
- **GROMMETS, BUMPERS & PLUGS** 19
- **ADHESIVES & CLEANERS** 22
- **TOOLS** 24
- **SCREW-TRACK COVERS** 25
- **INSTALLATION TIPS** 26
- **HOW-TO VIDEOS** 28



Steele Rubber Products 6180 E NC 150 HWY Denver NC 28037

steelerrubber.com

800-230-5897

STATIONARY GLASS

For a precise fit and complete seal, Steele Rubber Products offers high-quality dense rubber extrusions for all of your RV stationary glass needs. This is a listing of our most popular offerings. Please call 800-230-5897 or visit us on-line at steelerubber.com for additional profiles. Parts may be discounted for lengths over 50 feet.



LOCKSTRIP STYLE UNIVERSAL WINDOW SEAL

UNIVERSAL WINDOW SEAL DESIGN THAT USES A LOCKING STRIP TO COMPLETE THE INSTALLATION

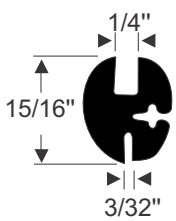
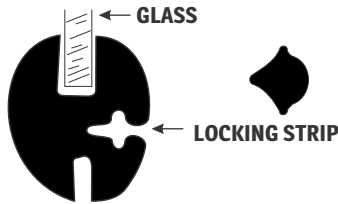

60-0082-257 • per/ft.
USES 60-0607-257 LOCKSTRIP

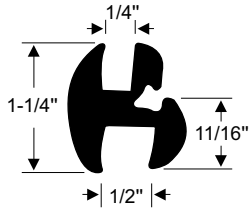

70-4774-257 • per/ft.
USES 60-0607-257 LOCKSTRIP

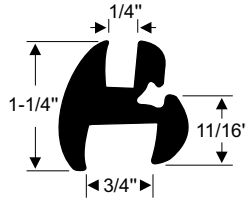

70-4775-257 • per/ft.
USES 60-0607-257 LOCKSTRIP

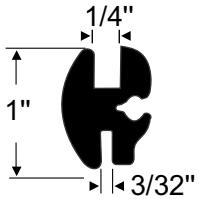

40-0548-257 • per/ft.
USES 60-0607-257 LOCKSTRIP

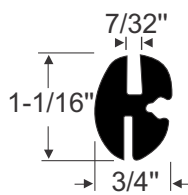

40-0496-257 • per/ft.
USES 30-0439-257 LOCKSTRIP



70-4299-257 • per/ft.
USES 60-0607-257 LOCKSTRIP

LOCKSTRIP

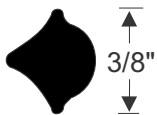

60-0607-257
per/ft.

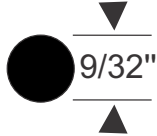

30-0439-257
per/ft.

SELF LOCKING

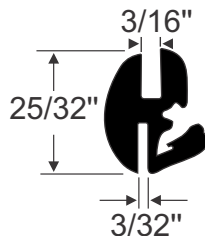

70-4068-257 • per/ft.

WINDOW CHANNEL

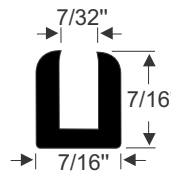

30-0044-257 • per/ft.

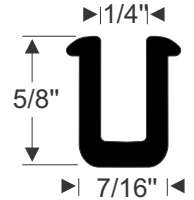

30-00507-257 • per/ft.

WINDOW CHANNEL SETTING FOR STATIONARY GLASS

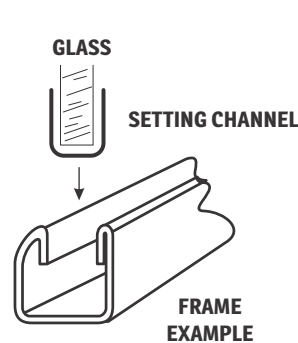

70-2169-257 • per/ft.

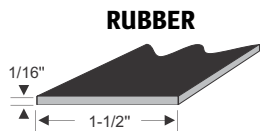

70-2170-257 • per/ft.

SLIDING GLASS

Steele Rubber Product's sliding glass seals are designed with ease of installation and superior function in mind. Samples are available to ensure an exact fit.

Please call 800-230-5897 or visit us on-line at steelerubber.com to order samples or learn about additional profiles.

Call or visit our website for current pricing

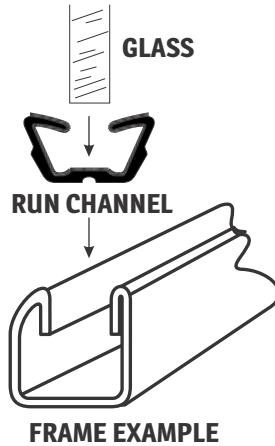

GLASS RUN CHANNEL

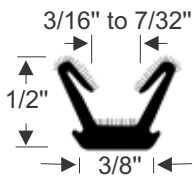

For 7/16" - 1/2" channel
70-3572-256 • 8' strip

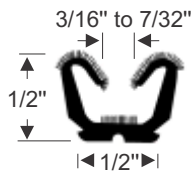

For 9/16" - 5/8" channel
70-3570-256 • 8' strip

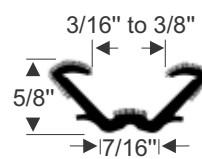

For 5/8" - 3/4" channel
70-3578-256 • 8' strip

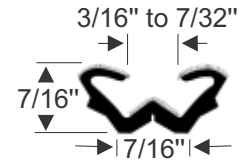

For 9/16" - 5/8" channel
70-3579-256 • 8' strip

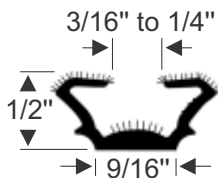

For 11/16" - 3/4" channel
70-3577-256 • 8' strip

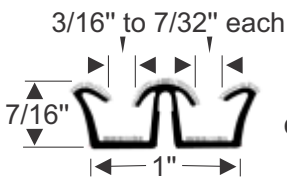

70-3571-256
8' strip
For 7/16" Individual channels
Or 15/16" channels w/o divider

GLASS CHANNEL LINER

Glass channel liner can be shaped and pressed into any channel track to make a smooth surface for glass to slide on.

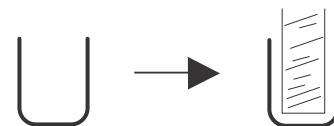

FORM TO FIT GLASS IN CHANNEL

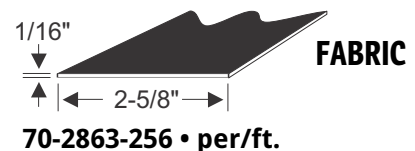

70-2863-256 • per/ft.

WINDOW GLAZING & OUTER TRIM

This weatherstrip is wedged between the glass and the retaining metal frame to provide a secure seal. Developed with functionality in mind, this EPDM rubber seal protects against extreme weather and eliminates noise and vibration.

WINDOW EDGE GLAZING

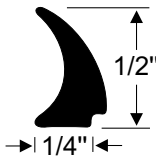
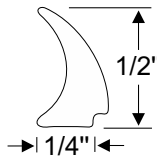
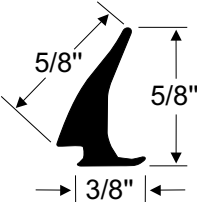
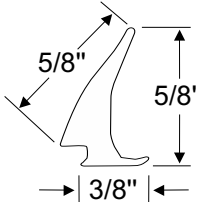
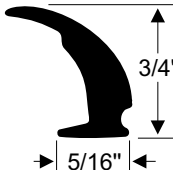
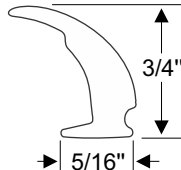
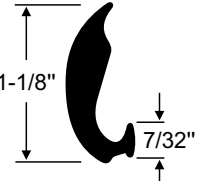
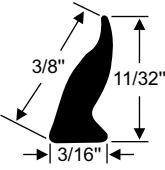
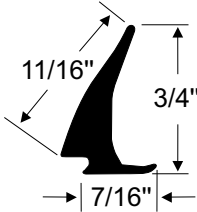
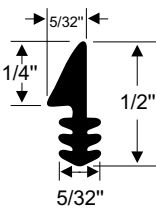
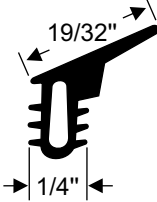
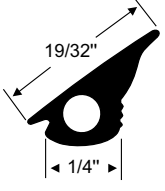
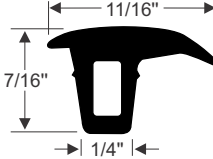
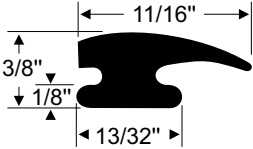
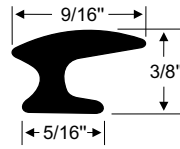
 <p>70-3814-257 per/ft.</p>	<p>WHITE RUBBER</p>  <p>70-4090-257 per/ft.</p>	 <p>70-4608-257 per/ft.</p>	<p>WHITE RUBBER</p>  <p>70-4771-257 per/ft.</p>	 <p>70-3857-256 per/ft.</p>	<p>WHITE RUBBER</p>  <p>70-4293-256 per/ft.</p>
 <p>70-4490-257 per/ft.</p>	 <p>70-4876-257 per/ft.</p>	 <p>70-4816-99 per/ft.</p>	 <p>70-4593-257 per/ft.</p>	 <p>70-4077-244 per/ft.</p>	 <p>70-4296-257 per/ft.</p>
 <p>70-4298-257 per/ft.</p>	 <p>30-0147-257 per/ft.</p>	 <p>70-4931-257 per/ft.</p>			

WINDOW CHANNEL TRIM

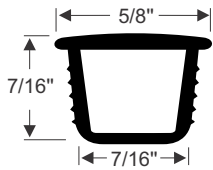
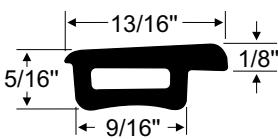
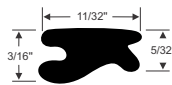
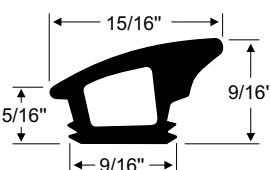
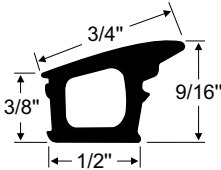
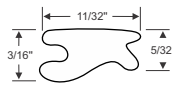
 <p>70-3824-255 per/ft.</p>	 <p>70-4933-240 per/ft.</p>	 <p>70-3825-255 per/ft.</p>
 <p>70-4500-257 per/ft.</p>	 <p>70-4939-255 per/ft.</p>	<p>WHITE RUBBER</p>  <p>70-4237-255 per/ft.</p>

GLAZING INSTALLATION TIP!



Does this look familiar?

The original vinyl glazing will shrink and look like the photos shown here. Our EPDM rubber replacement glazing is designed to NOT shrink and will look great for years to come.

- Remove the old, shrunken, and dry-rotted vinyl glazing from the window frame.
- Clean the track thoroughly and simply press the new rubber glazing seal into place. Trim to fit. It's that easy!

Call or visit our website for current pricing

SWING OUT GLASS SEALS

Steele Rubber Product's swing-out glass seals are designed with superior function and ease of installation in mind. The unique profiles maintain a positive and cushioning seal for the glass window without placing undue strain on hinges or latch mechanisms. Most are backed with 3M's Peel-N-Stick adhesive tape to resist the elements and will hold in place for years to come. Samples are available to ensure an exact fit.

Call or visit our website for current pricing

PEEL-N-STICK SWING OUT SEALS

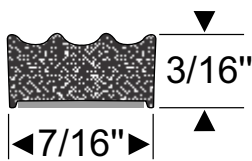

70-3846-277 • per/ft.

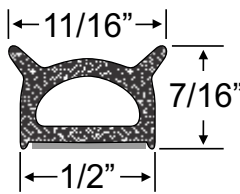

70-3847-277 • per/ft.

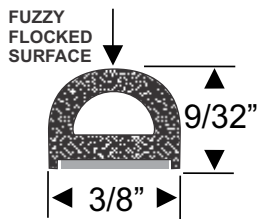

70-4062-255 • per/ft.

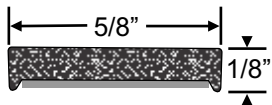

70-4205-272 • per/ft.

FIT IN TRACK GLASS SEALS

Some RV swing out windows & Awning windows feature a track for rubber to slide or press into.

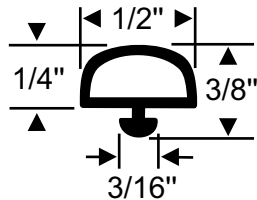

70-3978-277 • per/ft.

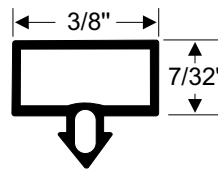

70-4123-254 • per/ft.



CRANK OUT WINDOW WEATHERSTRIP

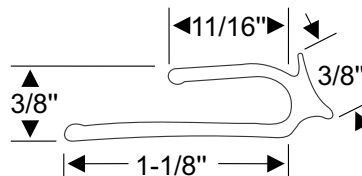

70-4878-254 • per/ft.
WHITE RUBBER

T-RUBBER SEALS

Steele Rubber Product's dense "T-Rubber" seals can be used in just about any application where rubber is held in place with a track or channel. Many RV screen doors and shower doors utilize T-Rubber seals.

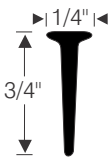

70-0142-272 per/ft.

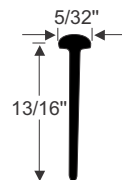

70-3788-272 per/ft.

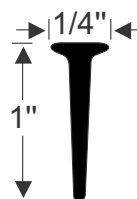

70-1163-272 per/ft.

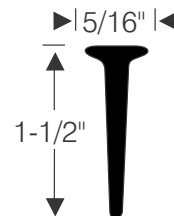

19-0024-272 per/ft.



DOORS

ACCESS DOORS & COMPARTMENT DOORS

Steele Rubber Product's push-on access door seals are designed to stop leaks, drafts, reduce noise and ensure a secure fit between the door and the frame of the RV. The tube-shaped bulbs consist of a high-quality, weather resistant rubber mated to a flexible edge trim that has an integrated steel core. The result is a long-lasting seal that is easy to install.



SIDE BULB PUSH-ON

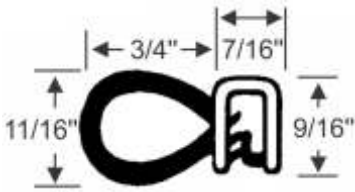

FOR 1/16" TO 1/8" EDGES
70-3582-277 • per/ft.

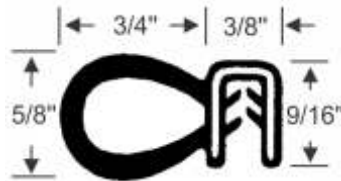

FOR 3/16" TO 1/4" EDGES
70-3583-277 • per/ft.

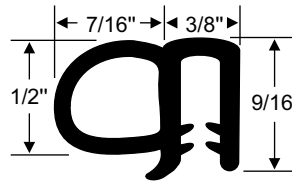

FOR 1/8" EDGES
70-3592-277 • per/ft.

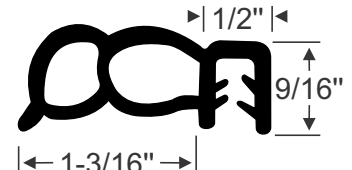

FOR 3/16" TO 1/4" EDGES
70-3885-277 • per/ft.

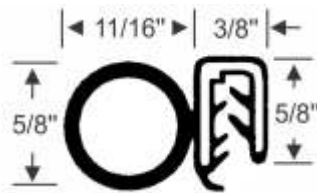

70-3584-277 • per/ft.

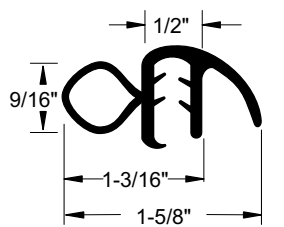

70-4144-277 • per/ft.

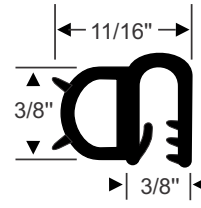

FOR 1/8" EDGES
70-3855-277 • per/ft.

TOP BULB PUSH-ON

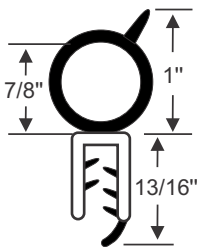

70-2831-277 • per/ft.

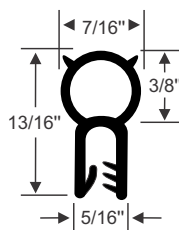

70-3854-245 • per/ft.

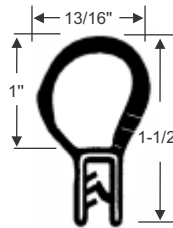

FOR EDGES UP TO 1/8"
70-3587-277 • 25ft. Roll

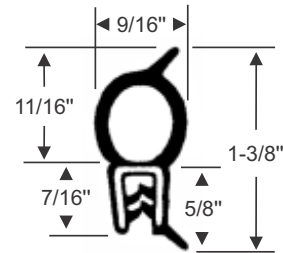

FOR 1/16" EDGES
70-3590-277 • per/ft.

SIDE LIP PUSH-ON

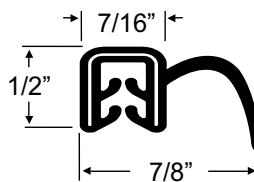

FOR 1/16" TO 1/8" EDGES
70-3801-277 • per/ft.

Call or visit our website for current pricing



DOORS

ACCESS DOORS & COMPARTMENT DOORS

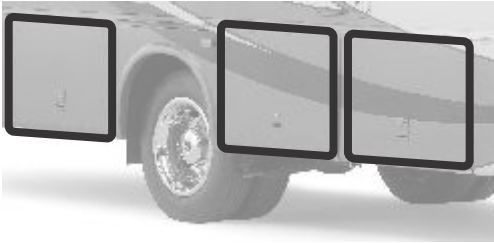

Access & compartment door seals are critical components in the effort to keep your RV interior and storage area dry and free from mildew and insect damage. Steele Rubber Products offers a wide variety of high-quality sponge rubber profiles with a 3M Peel-N-Stick backing. This means you will achieve a durable and lasting fit that is easy to install and sure to help protect your investment. Free samples are available to help determine the best profile. Contact one of our Product Specialists at 800-230-5897 today!

Call or visit our website for current pricing

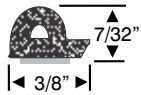

83-0102-277 • 5ft.
Also available in
10ft, 15ft, & 30ft

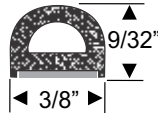

83-0104-277 • 5ft.
Also available in
10ft, 15ft, & 30ft

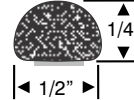

83-0127-277 • 5ft.
Also available in
10ft, 15ft, & 30ft

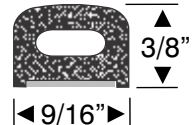

83-0109-277 • 5ft.
Also available in
10ft, 15ft, & 30ft

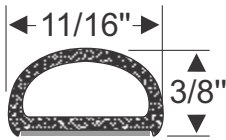

70-3848-277 • per/ft.

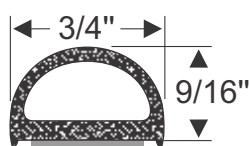

70-3859-283 • per/ft.

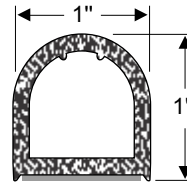

70-3850-283 • per/ft.

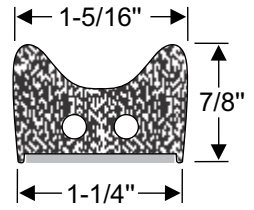

70-4644-245 • per/ft.

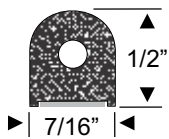

70-2085-277 • per/ft. Also available in 10ft, 15ft, & 30ft

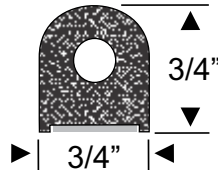

83-1023-283 • 5ft.
Also available in 10ft, 15ft, & 30ft

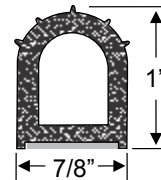

70-3677-265 • per/ft.

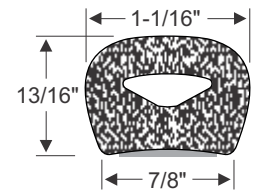

70-3972-272 • per/ft.

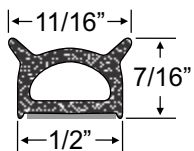

70-3847-277 • per/ft.

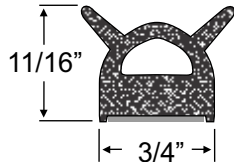

70-3802-283 • per/ft.

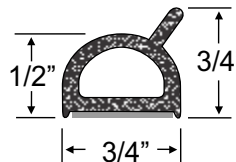

70-3984-283 • per/ft.

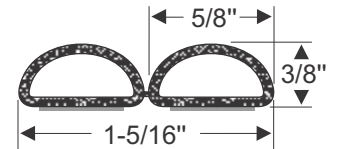

70-4057-277 • per/ft.

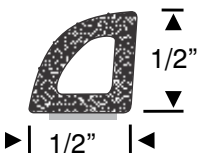

83-0125-277 • 5ft.
Also available in
10ft, 15ft, & 30ft

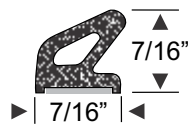

83-0128-277 • 5ft.
Also available in
10ft, 15ft, & 30ft

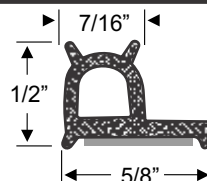

70-3852-272 • per/ft.

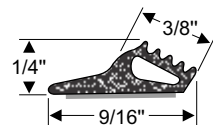

70-3858-277 • per/ft.

DOORS

Call or visit our website for current pricing

ACCESS DOORS & COMPARTMENT DOORS

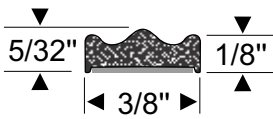

70-4624-277 • per/ft.

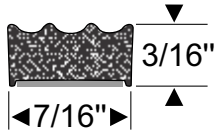

70-3846-277 • per/ft.

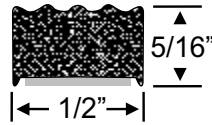

70-3672-277 • per/ft.

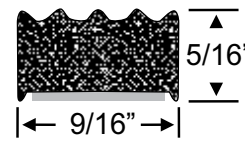

70-3673-277 • per/ft.

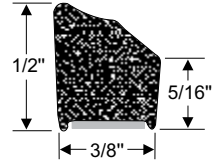

70-4756-257 • per/ft.

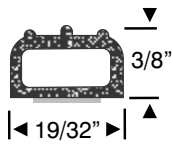

70-3676-277 • per/ft.

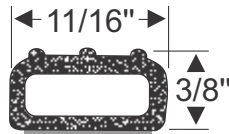

70-3849-277 • per/ft.

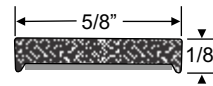

70-4205-272 • per/ft.

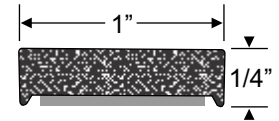

70-4204-277 • per/ft.

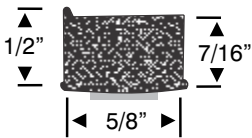

30-0144-277 • per/ft.

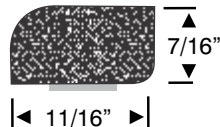

30-0243-277 • per/ft.

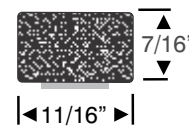

70-1105-277 • per/ft.

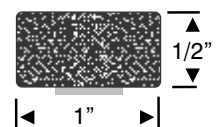

70-1106-277 • per/ft.

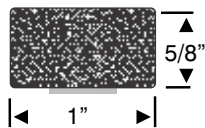

70-0129-277 • per/ft.

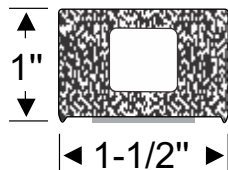

70-3872-265 • per/ft.

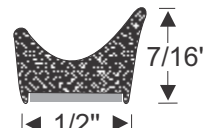

70-0331-272 • per/ft.

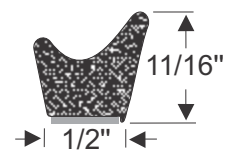

70-0145-277 • per/ft.

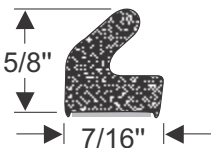

40-0480-277 • per/ft.

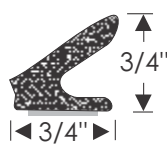

83-0139-277 • 10ft. Strip

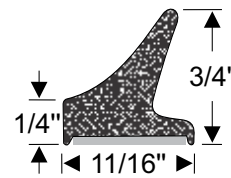

83-0137-277 • 10ft. Strip

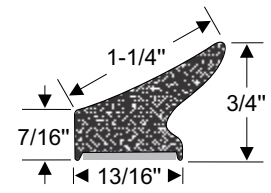

70-4504-277 • per/ft.

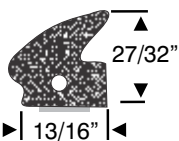

83-0123-277 • 10ft. Strip



70-4104-244 • per/ft.

FIT IN TRACK DOOR SEALS

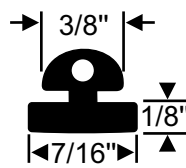

70-4079-245
per/ft.

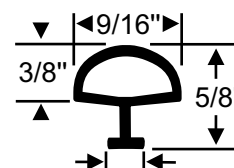

70-4067-245
per/ft.

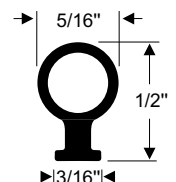

70-4302-277
per/ft.

DRIP RAIL, INSERT TRIM/BODY TRIM

Drip rails are used to catch and divert water away from windows, doors or other openings on the side of an RV, much like a gutter on a building. Steele Rubber Product's drip rails are made of high-quality weather resistant rubber with an easy to use 3M Peel-N-Stick adhesive. This ensures durability and a trouble-free installation.

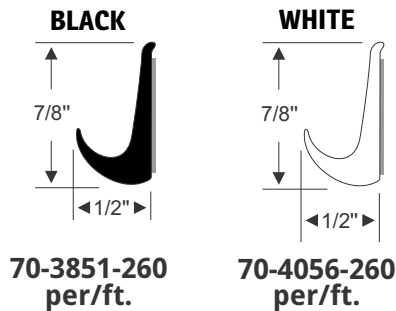

INSERT TRIM

Our insert trim rubber is the perfect replacement for the original vinyl. Vinyl has a tendency to crack and shrink, allowing water in the track which causes mildew and rust. This dense rubber insert trim is manufactured with UV resistant compounds and will look great for years to come. Designed to fit & lock into tracks found on many RV and Toy Hauler models. Available in black or white, sold per foot.

BODY TRIM

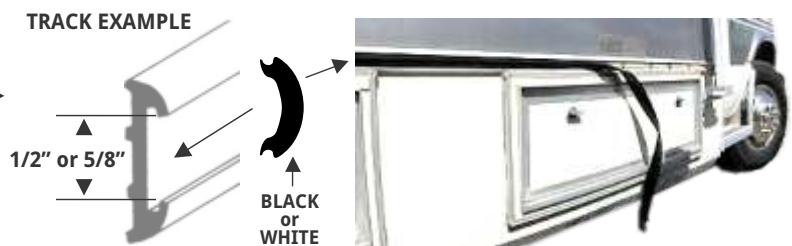
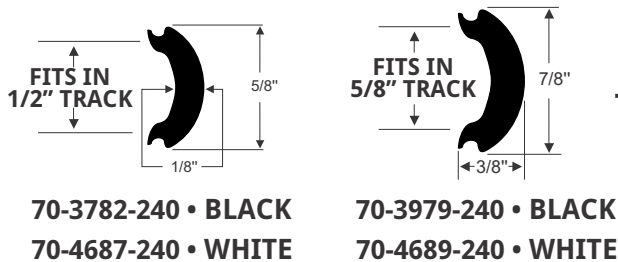
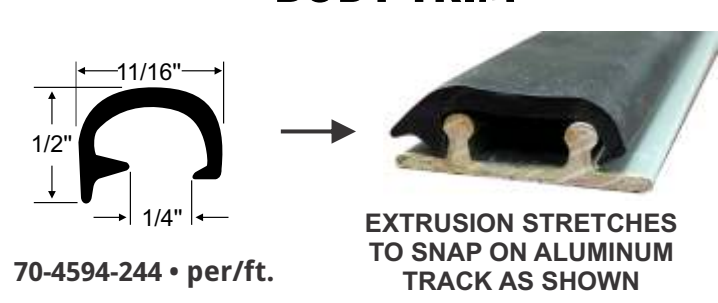

INSERT TRIM MOLDING BASE

A Peel-N-Stick Insert Trim Molding Base that can replace bent, broken, oxidized, or ill-fitting aluminum molding bases. Provides an economical option to expensive aluminum insert trim tracks on your RV. Top quality EPDM dense rubber with 3M adhesive backing.

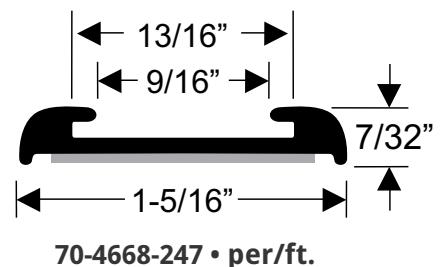

SLIDE-OUT SEALS

PRESS-IN SLIDE OUT SEALS FOR RVs

Improved replacement for cable operated slide-out systems

These unique and custom-designed seals are a replacement part for the cable operated slide-out systems commonly found on Forest River, Keystone, Jayco, Dutchman & Coachman brand RVs.

Constructed entirely out of a proprietary EPDM rubber that is highly wear and weather-resistant. Compare the factory original to our improved seals in the graphics below. 2 profiles to chose from.



The bonding point of the wiper and insertion stem is where the failure occurs



Ball-tipped wiper helps the seal move with the slide-out box

Crown tab enhances wiping action, protects from water intrusion and provides a finished look

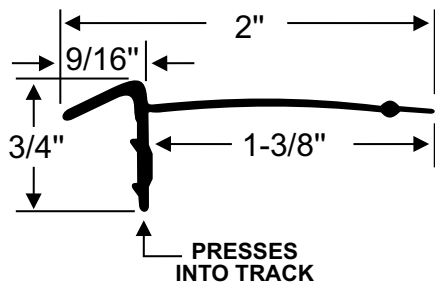

Part# 70-4184-265 • per/ft
Also available in 15ft 30ft & 60ft

All Rubber
100% EPDM Rubber
Highly Weather Resistant

Ball-tipped wiper helps the seal move with the slide-out box

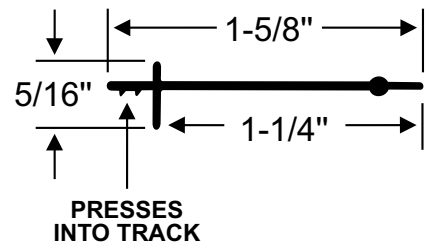

Part# 70-4773-265 • per/ft
Also available in 15ft 30ft & 60ft

Call or visit our website for current pricing

SLIDE-OUT SEALS

When choosing slide-out seals, be sure to note the type your RV has:

- Is it one or two-piece?
- How is it installed (glued-on, pushed-on, or does it utilize an adhesive tape)?
- What are the dimensions of the seals and the tracks they slide into and/or the surfaces that they adhere to (length, width and height)?

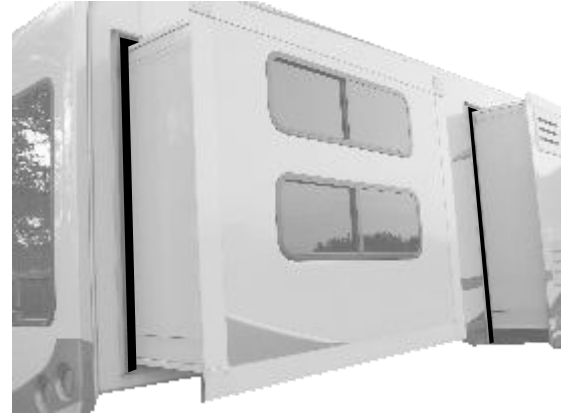

ONE PIECE
Push On

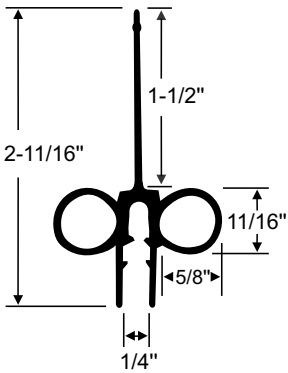

70-3716-265
40ft. Strip

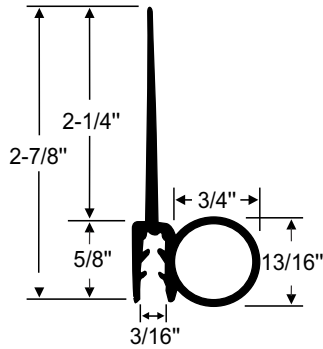

70-4349-265
40ft. Strip

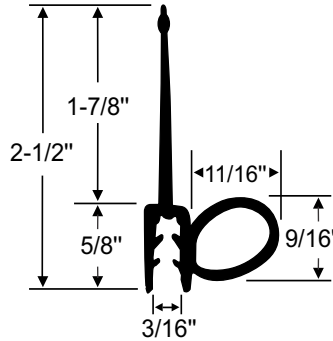

70-3714-265
40ft. Strip

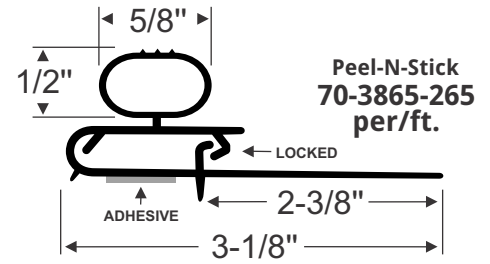
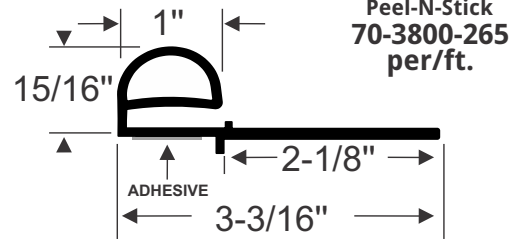

DENSE RUBBER
Peel-N-Stick

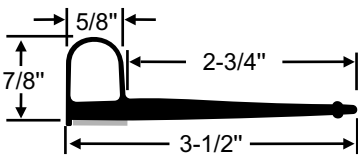

70-3712-265 • per/ft.

SPONGE RUBBER
Peel-N-Stick

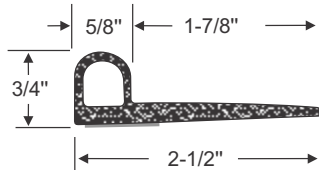

70-4174-265 • per/ft.

SPONGE RUBBER
Peel-N-Stick
BLACK or WHITE

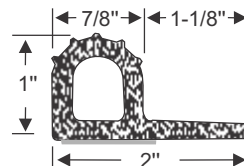

70-4186-265 • BLACK
70-3711-265 • WHITE

SPONGE RUBBER
Peel-N-Stick

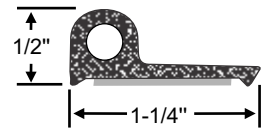

70-3708-265 • per/ft.

DENSE RUBBER
EXACT-SLIDE STYLE

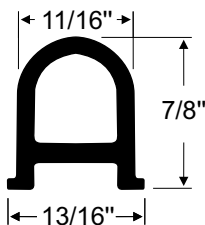

70-4943-265 • per/ft.

SPONGE RUBBER
Peel-N-Stick

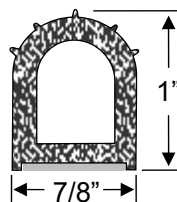

70-3677-265 • per/ft.

SPONGE RUBBER
Peel-N-Stick

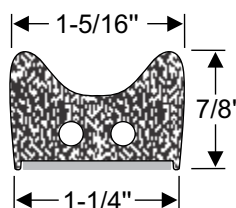

70-4644-245 • per/ft.

PUSH ON
FOR 1/8" EDGES

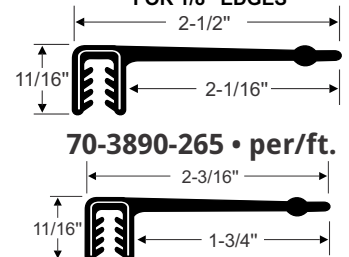

70-3890-265 • per/ft.

70-3889-265 • per/ft.

SLIDE-OUT SEALS



Slide-outs seals can be the most important weatherstripping found on an RV! Worn or poor-quality seals can easily lead to extensive and expensive damage. Generally consisting of a 'wiper' and a round seal called a 'bulb', the wiper seals the gap between the side of the RV body and the slide-out when the slide-out is extended. The bulb makes a seal between the body of the RV and the outside wall edge of the slide-out when retracted. Steele Rubber Products offers you precision-made high-quality rubber seals in a number of profiles to fit just about any configuration.

Call or visit our website for current pricing

WIPER WITH TRACK

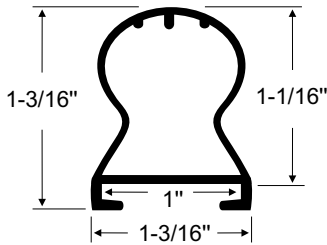

70-3834-265 • per/ft.

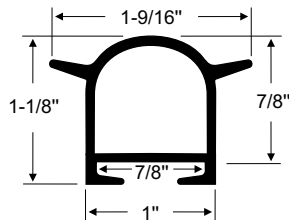

70-3969-265 • per/ft.

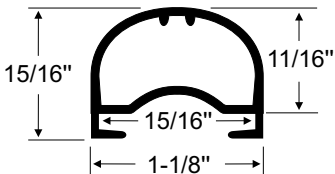

70-3882-265 • per/ft.

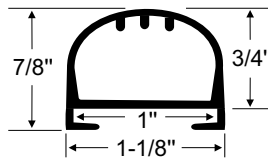

70-3833-265 • per/ft.

See page 25 for screw track covers and custom slide out options

BULB STYLE

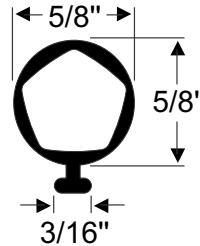

70-3795-265 • per/ft.

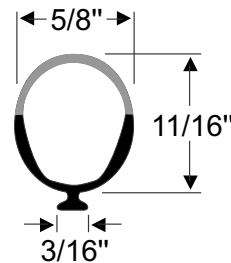

70-3831-265 • per/ft.

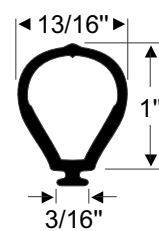

70-3832-265 • per/ft.

PRESS-ON

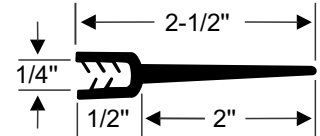

70-3710-265 • per/ft.

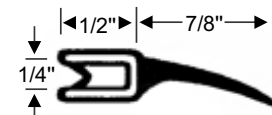

70-3591-265 • per/ft.

With 3M Peel-N-Stick adhesive

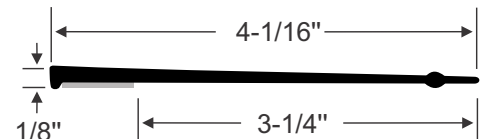

70-3899-265 • per/ft.

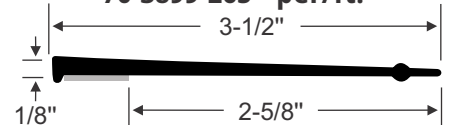

70-3856-265 • per/ft.

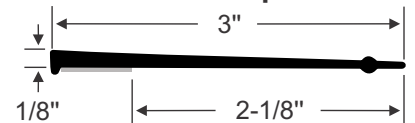

70-3709-265 • per/ft.

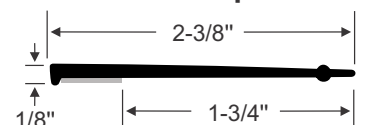

70-4667-265 • per/ft.

With 3M Peel-N-Stick adhesive

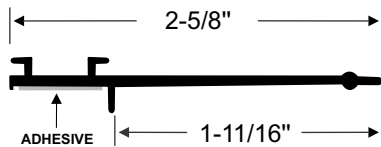

70-3884-265 • per/ft.

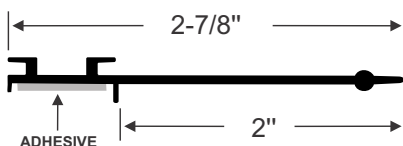

70-3883-265 • per/ft.

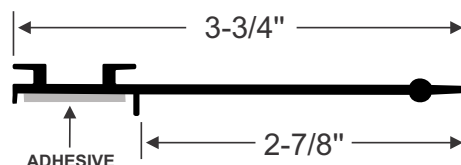

70-3835-265 • per/ft.

SLIDE-OUT FLIPPER BUMPER SET



SUGGESTED ORIENTATIONS

This four (4) piece Slide-Out Flipper Bumper Set is designed to "flip" the wiper weatherstrip when cycling the slide-out of your RV in or out.

This Steele Rubber Products flipper bumper set is manufactured from top quality EPDM dense rubber. Bumper strips have a peel-n-stick adhesive strip for easy (no gluing) and secure installation.



3M
ADHESIVE

90-3694-270
INCLUDES
(4) 18" STRIPS

SLIDE-OUT "H" SEAL PARTIAL REPAIR

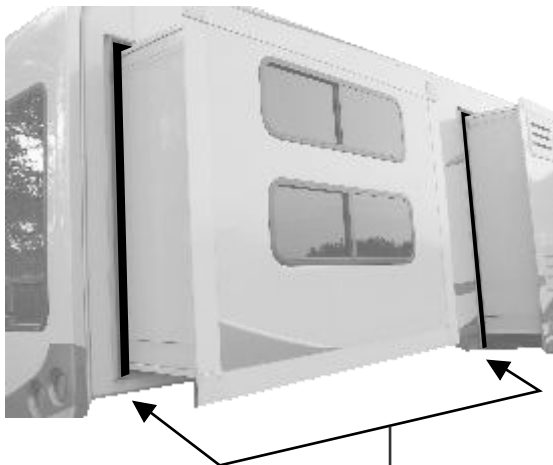

Many new RVs feature 'H' shaped, combination dual-wiper and bulb slide-out seals. This seal design is used to expedite production. Frequently, it is only the exterior half of the seal that becomes worn or damaged. Steele Rubber Products offers several options on page 10 of this catalog to help you save money and repair or replace only what is needed.

- Save money by replacing only what you need to.
- Re-use parts that are still in good condition.
- Easy to install and readily available replacement parts.

HOW TO TIPS:

- See our installation video for a start-to-finish guide.
- When only the wiper is damaged, remove, clean and re-use the slide-on bulb and track seal.
- When replacing a damaged wiper, be sure to remove the track base as well as the wiper to allow room for the replacement.

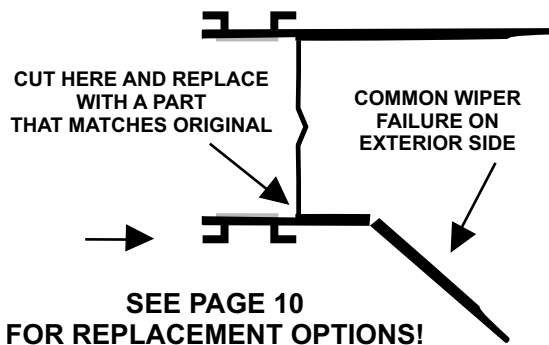

Be sure to visit our YouTube channel for installation and repair tips.
www.youtube.com/steelerubberproducts

RAMP-GATE KITS

Steele Rubber Products now offers complete, Ramp-Gate Kits for your RV or enclosed trailer. Each Ramp-Gate Kit comes with the following base components: sponge block corner seal (enough for both bottom corners), a seal compatible scraper/ tuck tool, Loctite Super Bonder 495 adhesive, and an instruction sheet. Choose from the 3 profiles below to complete your kit. The profile you choose will be cut to a 35ft. length and packaged along with the base components.



Call or visit our website for current pricing

RIBBED HOLLOW BULB SEAL

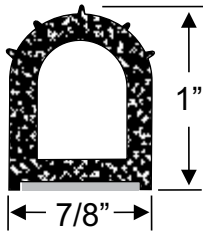

INCLUDES:

- 35ft of extrusion
- Sponge block corner seals
- Scraper tool
- Loctite Adhesive
- Instruction sheet

90-3326-283

LARGE HOLLOW HALF ROUND SEAL

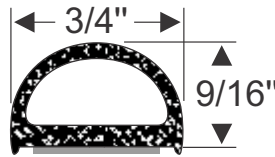

- 35ft of extrusion
- Sponge block corner seals
- Scraper tool
- Loctite Adhesive
- Instruction sheet

90-3327-283

LARGE HOLLOW HALF ROUND SEAL WITH DOUBLE TABS

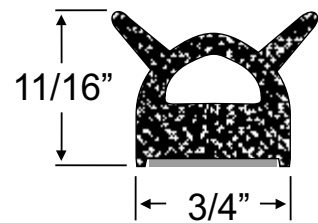

- 35ft of extrusion
- Sponge block corner seals
- Scraper tool
- Loctite Adhesive
- Instruction sheet

90-3328-283

HATCHES



Steele Rubber Product's hatch seals are made with high-quality materials designed to ensure leak-proof closures: keeping the weather out when your egress, sun-roof and vent hatches are closed. Don't replace the entire vent assembly when all you need is new weatherstripping!

Samples to ensure an exact fit and information on additional profiles are available by calling 800-230-5897, visiting us on-line at steelerubber.com or emailing us at rv@steelerubber.com.

Parts may be discounted for lengths over 50 feet.

Call or visit our website for current pricing

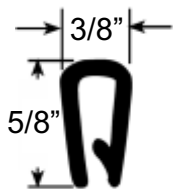

FOR 1/8" TO 3/16" EDGES
70-3600-244 • per/ft.

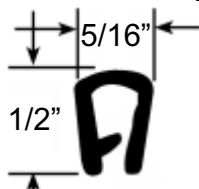

FOR 1/8" EDGES
70-3601-244 • per/ft.

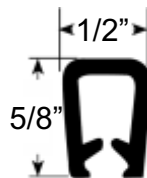

FOR 3/16" TO 1/4" EDGES
70-3598-244 • per/ft.

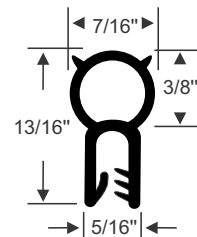

70-3854-245 • per/ft.

PUSH-ON

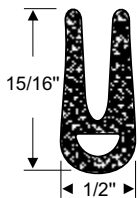

SPONGE RUBBER

70-2118-245 • per/ft.
83-0115-245 • 10ft.
83-0116-245 • 15ft.

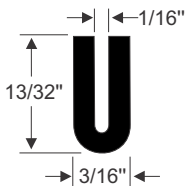

DENSE RUBBER

70-3166-244 • per/ft.
70-3167-244 • 10ft.
70-3168-244 • 15ft.

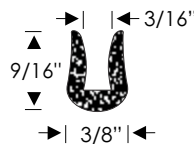

SPONGE RUBBER

70-2119-245 • per/ft.
83-0120-245 • 10ft.
83-0121-245 • 15ft.

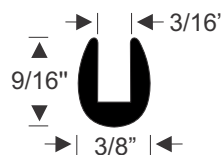

DENSE RUBBER

70-3246-244 • per/ft.
70-3247-244 • 10ft.
70-3248-244 • 15ft.

GLUE-ON

PEEL-N-STICK SPONGE RUBBER



83-0128-277 • 5ft.
Also available in
10ft, 15ft, & 30ft

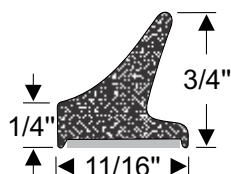

70-1437-277 • per/ft.

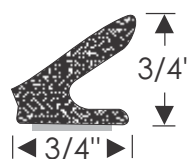

83-0139-277 • 10ft.

FIT IN TRACK SPONGE RUBBER

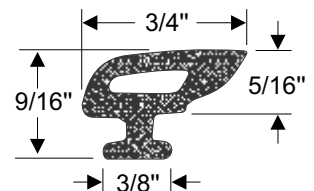

70-3904-245 • per/ft.

ROOF MOUNTED A/C, HEAT-PUMP GASKET



Unique high quality ONE-PIECE SPONGE EPDM replacement A/C, Heat-Pump Gasket. Fits most RV and marine A/C, heat-pump units including those made by Dometic and Coleman. One-piece design ensures no-leak functionality. High-quality closed cell EPDM sponge rubber yields higher UV, ozone and weather resistant durability than what is originally supplied! Easy to use pressure sensitive adhesive backed.

**STANDARD A/C GASKET KIT
PART# 70-3905-207**

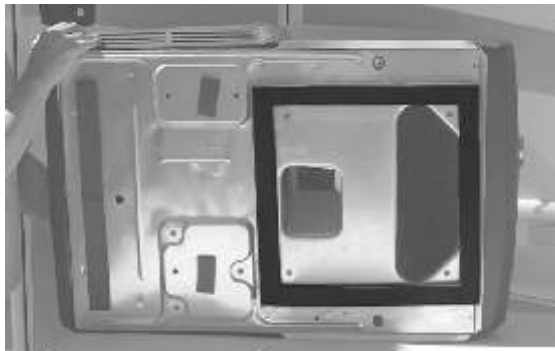
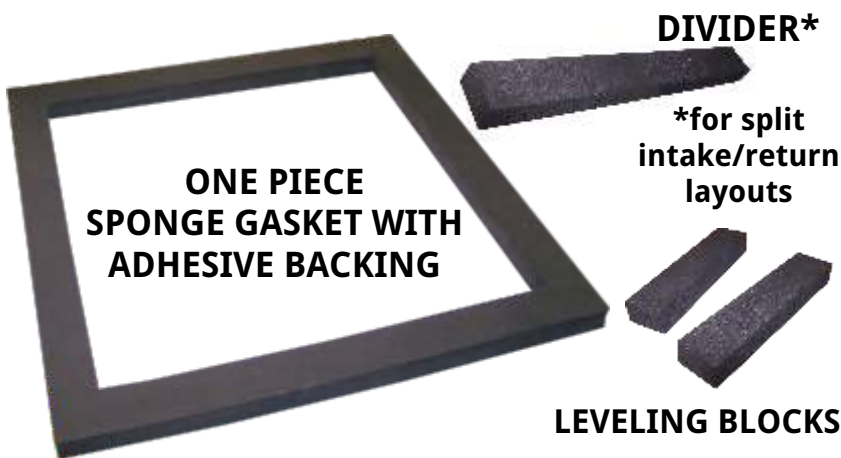

**A/C GASKET
PLENUM DIVIDER
AVAILABLE SEPARATELY
PART# 70-4284-207**

This one piece angled 1" x 1/1/2" inch Plenum Divider strip is made of the same top quality materials as our A/C Gasket Kit. Serves as a high-quality one-piece divider for those RV roof-mounted A/C and Heat Pump units that require a division piece.

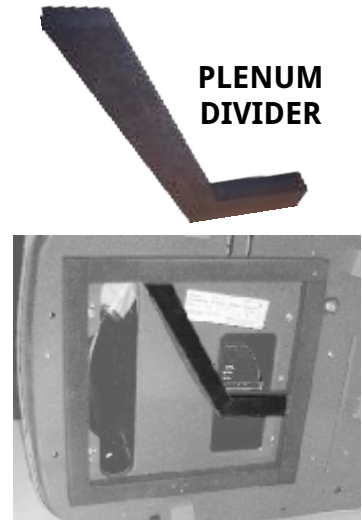

YouTube
HOW TO!

Be sure to watch the installation video on our YouTube Channel! "RV Education 101" shows you how to replace an old gasket with our exclusive 1-piece design. You can find the video on the product page of our website, or on our YouTube page . . .

youtube.com/SteeleRubberProducts

VINTAGE TRAILER SEALS

Steele Rubber Products is pleased to present to you a selection of seals and weatherstripping that can be used to restore vintage recreational vehicles. Applying our decades of experience producing better-than-original rubber parts for automobile restoration, you can be assured of the quality, fit and ease of installation of each of these products.



Samples are available to ensure an exact fit and we invite you to call 800-230-5897, visit us on-line at steelerubber.com or email us at rv@steelerubber.com for additional profiles. Likewise, we have built our business meeting our customer's needs, so send us a sample of your RV's old seals and we'll be glad to speak with you about making a replacement!

Call or visit our website for current pricing

PILE WEATHERSTRIP

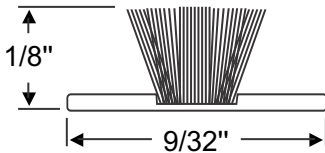

70-3842-256 • 25ft.

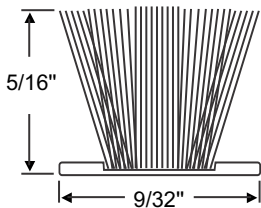

70-3843-256 • 25ft.

JALOUSIE GLASS RETAINER DISCS

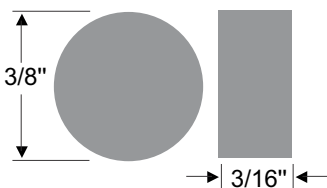

GRAY RUBBER
70-3837-254 • 25pc. set

HEHR STANDARD BACKFRAME GASKET

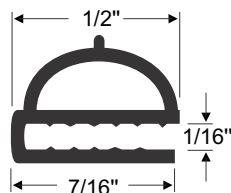

70-3839-254 • per/ft.

HEHR CLEAR-VIEW GLAZING STRIP

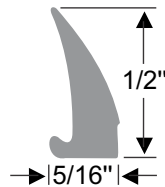

GRAY RUBBER
70-3840-257 • per/ft.

HEHR HALLMARK CLOSING SEAL

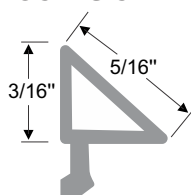

GRAY RUBBER
70-3844-254 • per/ft.

HEHR JALOUSIE D-SEAL

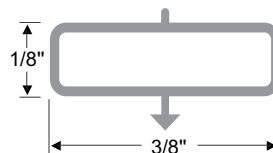

GRAY RUBBER
70-3845-254 • per/ft.

HEHR JALOUSIE WINDOW EDGE SEAL

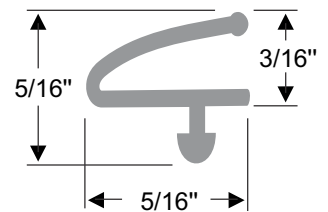

GRAY RUBBER
70-3841-254 • per/ft.

HEHR VERTICAL WINDOW EDGE WEATHERSTRIP

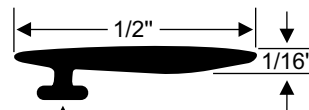

PRESSES INTO TRACK

70-4875-257 • per/ft.

HEHR STANDARD GLASS SEAL

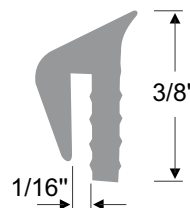

GRAY RUBBER
70-3838-257 • per/ft.

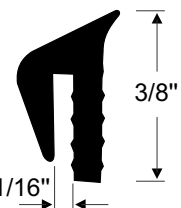

BLACK RUBBER
70-3983-257 • per/ft.

UNIVERSAL - TRUCK CAPS & TONNEAU COVERS

Steele Rubber Products now offers weatherstripping for your tonneau covers, truck bed caps, and camper shells. Designed with ease of installation and durability in mind, our seals are extruded in highly weather and use-resistant EPDM sponge and dense rubber. Unlike vinyl, this rubber will not shrink, fade or crack over time and with exposure to harsh conditions. While the profiles shown below are some of the most common, finding the BEST seal is often more dependent on your actual set-up than what was originally supplied. We recommend you take the time and measure the gaps that need to be sealed and then choose accordingly. Many of our compartment and door seals featured on pages 6-8 will support the customization of your project. Check out our tonneau cover installation video for more information . . . youtube.com/steelerubberproducts

**FIT IN TRACK
BOTTOM OF DOOR SEALS**

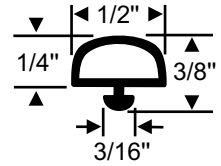

70-3978-277 • per/ft.

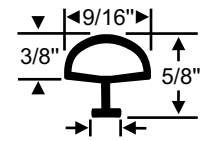

70-4067-245 • per/ft.

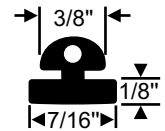

70-4079-245 • per/ft.

**CAMPER SHELL
SUPPORT CUSHION**

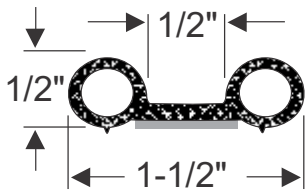

70-3897-283 • per/ft.



ROOF RACK INSERT STRIPS

Replacement track inserts for Rhino-Rack Vortex roof-rail systems. Components also fit other brands, including Thule.

Call or visit our website for current pricing

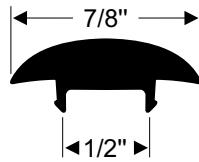

70-4681-240
per/ft.

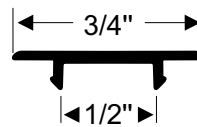

70-4682-240
per/ft.

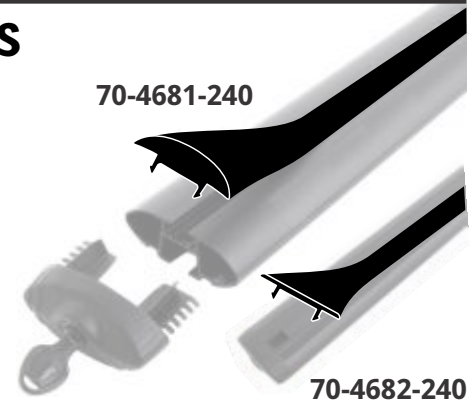

70-4681-240

70-4682-240

HEAVY DUTY BODY BUMPER AND END CAP

Designed to snap into a track, this shock-absorbing body bumper makes a perfect protective edging for RV's of all shapes and sizes. Our new END CAP finishes the job beautifully.

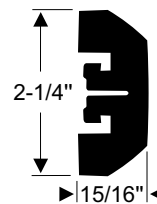
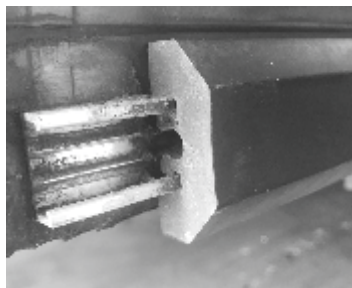

EXTRUSION
70-4093-247 • per/ft.

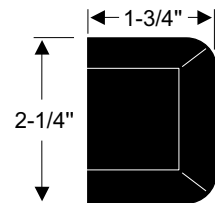

END CAP
70-4177-247 • ea.

ROUND GROMMETS

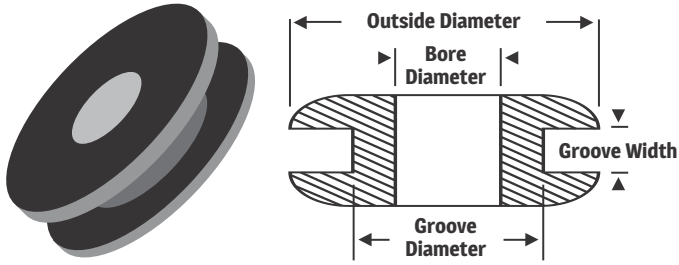

GROOVE DIAMETER = PROJECT HOLE SIZE

Part Number	GROOVE DIAMETER	Bore Diameter	Outside Diameter	Groove Width
32-1059-20	1/4"	5/32"	3/8"	1/16"
32-1060-20	1/4"	5/32"	7/16"	3/32"
32-1062-20	9/32"	5/32"	13/32"	3/32"
32-1063-20	5/16"	5/32"	7/16"	1/4"
32-1061-20	5/16"	3/16"	1/2"	1/16"
32-0352-20	3/8"	1/4"	9/16"	1/16"
32-0414-32	3/8"	5/32"	9/16"	5/32"
32-1064-20	3/8"	1/4"	1/2"	1/16"
32-1058-20	3/8"	1/8"	1/2"	3/32"
32-0514-20	3/8"	1/4"	5/8"	1/16"
32-0317-52	7/16"	1/4"	3/4"	1/16"
32-0366-53	7/16"	1/8"	5/8"	1/16"
32-1065-20	7/16"	1/4"	5/8"	1/16"
32-0537-24	7/16"	1/4"	3/4"	1/16"
32-1067-20	7/16"	5/16"	9/16"	1/16"
32-0365-20	1/2"	3/16"	3/4"	1/16"
32-0161-21	1/2"	3/8"	11/16"	1/16"
32-0132-67	1/2"	3/8"	13/16"	3/32"
32-1073-20	9/16"	7/16"	3/4"	1/16"
32-1070-20	9/16"	5/16"	13/16"	1/4"
32-0051-24	9/16"	3/8"	5/8"	5/32"
32-0491-21	9/16"	3/8"	15/16"	5/32"
32-1069-20	9/16"	5/16"	3/4"	1/8"
32-0158-17	9/16"	5/16"	13/16"	1/16"
32-1071-20	5/8"	3/8"	7/8"	1/16"
32-1072-20	5/8"	3/8"	7/8"	1/4"
32-0970-17	5/8"	7/32"	13/16"	3/32"
32-0112-20	11/16"	1/4"	1-3/16"	1/16"
32-0047-14	11/16"	3/8"	1"	1/16"
32-0165-15	11/16"	1/8"	15/16"	1/16"
32-0050-24	11/16"	15/32"	3/4"	1/4"
32-0003-21	11/16"	5/16"	1"	1/16"
32-0328-54	11/16"	3/8"	1-3/16"	1/16"
32-1068-20	3/4"	5/16"	1"	1/16"
32-0342-24	3/4"	3/8"	1"	3/16"
32-1075-20	3/4"	1/2"	1"	1/8"
32-0438-20	3/4"	1/2"	1"	3/32"
32-1074-20	3/4"	1/2"	31/32"	3/32"

Part Number	GROOVE DIAMETER	Bore Diameter	Outside Diameter	Groove Width
32-0263-17	3/4"	5/16"	1"	1/16"
32-0066-20	3/4"	1/4"	15/16"	1/16"
32-0162-21	3/4"	1/4"	15/16"	1/16"
32-0064-21	13/16"	1/4"	1"	1/16"
32-1076-20	13/16"	1/2"	1-1/16"	1/4"
32-0002-21	7/8"	13/32"	1-1/16"	1/16"
32-0224-21	7/8"	5/8"	1-1/8"	1/16"
32-1077-20	7/8"	5/8"	1-1/8"	1/8"
32-0057-24	7/8"	5/16"	1-1/4"	1/8"
32-0155-37	7/8"	1/2"	1-5/16"	1/16"
32-0364-37	29/32"	5/8"	1-1/4"	3/32"
32-1078-20	15/16"	3/4"	1-1/8"	1/16"
32-0039-14	15/16"	1/4"	1-1/4"	1/16"
32-0133-21	31/32"	3/4"	1-3/16"	3/16"
32-1066-20	31/32"	1/4"	1-7/32"	1/16"
32-0464-15	1"	3/8"	1-3/8"	1/16"
32-0714-41	1"	3/8"	1-5/16"	1/16"
32-0492-14	1"	11/16"	1-1/4"	1/16"
32-0320-21	1"	7/16"	1-7/16"	1/16"
32-0439-20	1"	7/16"	1-5/16"	1/16"
32-0390-21	1"	3/4"	1-1/4"	1/16"
32-0098-21	1"	1/4"	1-5/16"	1/16"
32-0401-45	1"	3/8"	1-1/4"	1/16"
32-0437-20	1-1/16"	7/16"	1-3/8"	1/16"
32-0253-37	1-1/16"	5/8"	2-1/16"	3/32"
32-0369-20	1-1/16"	3/4"	1-3/8"	1/16"
32-0134-20	1-1/16"	13/16"	1-5/16"	5/32"
32-1201-20	1-3/32"	9/16"	1-9/16"	3/32"
32-0167-52	1-3/32"	7/8"	1-7/16"	1/16"
32-0005-14	1-1/8"	5/8"	1-3/8"	1/16"
32-0001-37	1-1/8"	3/4"	1-9/16"	1/16"
32-0365-37	1-5/32"	5/8"	1-9/16"	3/32"
32-0062-14	1-5/32"	3/4"	1-7/16"	1/16"
32-0355-37	1-1/4"	5/8"	2"	1/16"
32-1079-20	1-1/4"	3/4"	1-5/8"	1/4"
32-0421-37	1-1/4"	3/4"	1-9/16"	1/4"
32-0422-20	1-1/4"	1/2"	1-7/16"	1/4"
32-0220-21	1-1/4"	1/4"	1-1/2"	1/16"
32-0118-37	1-1/4"	3/4"	1-5/8"	1/16"
32-0063-14	1-5/16"	1/2"	1-5/8"	1/16"
32-0455-14	1-5/16"	7/8"	1-5/8"	1/16"
32-0023-14	1-5/16"	1-1/16"	1-7/8"	1/16"
32-0196-21	1-5/16"	5/16"	1-11/16"	1/16"
32-0160-20	1-3/8"	1/2"	1-11/16"	1/8"
32-0062-20	1-3/8"	5/16"	1-7/8"	1/8"
32-0333-20	1-3/8"	7/16"	1-3/4"	3/32"
32-0225-20	1-1/2"	11/16"	2-1/4"	3/32"

STEM BUMPERS



This is a sample design. Actual stem bumpers may be different.

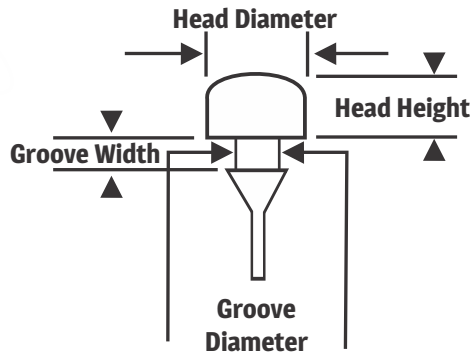

GROOVE DIAMETER = PROJECT HOLE SIZE

Our stem bumpers can be used to protect a variety of applications. Bumpers are listed below by the size of the Groove Diameter (which is the project hole size). Please call if you need assistance.

Call or visit our website for current pricing

Part Number	GROOVE DIAMETER	Head Diameter	Head Height	Groove Width
33-0730-42	1/8"	3/8"	3/32"	1/8"
33-0127-41	1/8"	5/16"	1/8"	1/16"
33-0128-88	1/8"	5/16"	1/4"	1/16"
33-0556-15	1/8"	1/2"	1/16"	7/32"
33-0348-54	3/16"	1/2"	5/8"	1/16"
33-0368-30	3/16"	1/2"	7/16"	1/8"
33-0507-62	3/16"	7/16"	1/8"	5/32"
33-0990-87	3/16"	15/16"	1/2"	1/16"
33-0117-42	3/16"	5/8"	5/16"	1/16"
33-0349-87	3/16"	1/2"	3/32"	1/16"
33-0042-42	3/16"	7/16"	1/2"	1/16"
33-0123-42	1/4"	3/4"	1/2"	1/16"
33-0512-44	1/4"	3/8"	5/32"	1/16"
33-0136-42	1/4"	1/2"	5/16"	1/16"
33-0211-31	1/4"	5/8"	1/4"	1/16"
33-0293-87	1/4"	7/8"	5/16"	1/16"
33-0459-42	1/4"	3/4"	3/16"	1/16"
33-0496-71	1/4"	1/2"	3/8"	1/16"
33-1285-42	1/4"	9/16"	3/16"	1/16"
33-0395-42	1/4"	9/16"	3/32"	1/16"

Part Number	GROOVE DIAMETER	Head Diameter	Head Height	Groove Width
33-0350-87	1/4"	15/16"	3/8"	1/16"
33-0427-42	1/4"	5/8"	3/16"	1/16"
33-0482-42	1/4"	5/8"	7/16"	1/16"
33-0046-42	1/4"	3/4"	5/16"	1/16"
33-1574-71	1/4"	5/8"	1/4"	1/16"
33-0003-42	1/4"	11/16"	1/8"	3/32"
33-0019-20	1/4"	15/32"	3/16"	1/16"
33-0449-42	1/4"	1/2"	1/4"	1/16"
60-0734-71	1/4"	9/16"	1/4"	1/16"
33-1576-71	5/16"	9/16"	1/2"	1/16"
33-1575-71	5/16"	5/8"	3/4"	1/16"
33-0531-42	5/16"	13/16"	1/4"	1/8"
33-0031-42	5/16"	1/2"	1/8"	1/16"
33-0109-71	5/16"	3/4"	1/4"	3/32"
33-0116-42	5/16"	3/4"	7/16"	3/32"
33-0542-42	5/16"	3/4"	5/16"	1/16"
33-0113-42	5/16"	3/4"	3/16"	1/16"
33-0293-71	5/16"	3/4"	11/16"	1/16"
33-0016-45	3/8"	1"	11/32"	1/16"
33-0169-42	3/8"	11/16"	3/8"	1/16"

Stem bumpers come in a variety of shapes. These are examples of different stem bumpers.



Part# 33-0127-41



Part# 33-0348-54



Part# 33-0211-31

ROUND BODY PLUGS

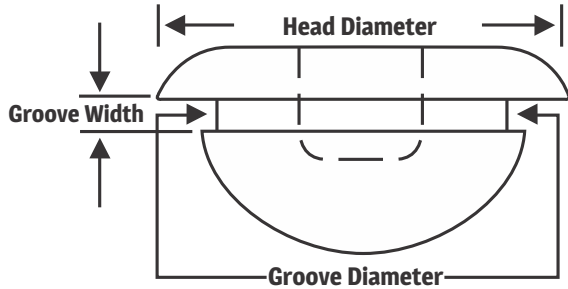

Our body plugs can be used for a variety of applications. Body Plugs are listed by the size of the groove diameter. (which is the project hole size). Please call if you need assistance.

GROOVE DIAMETER = PROJECT HOLE SIZE

Part Number	GROOVE DIAMETER	Head Diameter	Material	Groove Width
35-0458-45	3/8"	5/8"	Rubber	1/8"
35-0369-20	1/2"	3/4"	Rubber	3/32"
35-0070-87	1/2"	3/4"	Rubber	1/16"
35-1052-20	1/2"	7/8"	Plastic	1/16"
35-0171-20	9/16"	13/16"	Rubber	None*
35-0197-31	3/4"	1-1/8"	Rubber	3/32"
35-0262-20	3/4"	1"	Rubber	1/16"
35-0515-20	3/4"	1"	Rubber	1/16"
35-1053-20	3/4"	1-1/8"	Plastic	1/16"
35-1054-20	3/4"	1-1/4"	Plastic	1/16"
35-0402-87	7/8"	1-3/32"	Rubber	1/16"
35-0099-20	15/16"	1-3/16"	Rubber	1/16"
35-1214-20	1"	1-5/16"	Rubber	1/16"
35-0457-45	1"	1-3/8"	Rubber	1/16"
35-1055-20	1"	1-3/8"	Plastic	1/16"
35-0327-45	1-1/8"	1-1/2"	Rubber	1/16"
35-1056-20	1-1/4"	1-5/8"	Plastic	1/16"
35-0517-45	1-3/8"	1-5/8"	Rubber	1/16"
35-3508-45	2"	2-7/16"	Rubber	3/32"

*Part# 35-0171-20 has NO groove

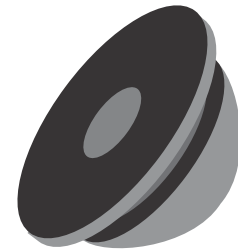

This is a sample design.

Body plugs come in a variety of sizes. These are examples of our body plugs.



Part# 32-0456-20



Part# 35-0369-20



Part# 35-1214-20

Call or visit our website for current pricing

3M Super Strength Molding Tape



3M Super Strength Molding Tape is ideal for permanently attaching side moldings and trim to your vehicles, adding long-term protection and value. This tape features an extremely strong adhesive that's also easy to use. Just pull of the red liner and apply. 2 widths available.

96-3616-96 - 7/8" WIDE TAPE

96-3614-96 - 1/2" WIDE TAPE

3M Super Weatherstrip Adhesive Available in Black or Yellow (2 oz.)*



Designed specifically to bond rubber gaskets and weatherstripping to metal surfaces. This flexible, high-strength adhesive helps ensure a tight waterproof seal on car doors, trunks, roof rails and more. 2 oz. tube.

96-8581-296 - BLACK

96-8002-96 - YELLOW

3M Super Weatherstrip Adhesive Black or Yellow (5 oz.)*



This Super Weatherstrip Adhesive is designed to bond seals and gaskets to metal to ensure a waterproof and airtight seal inside your vehicle. This adhesive is ideal for weatherstripping around doors, trunk, t-tops, sunroofs, and windows. This adhesive creates a permanent bond when used on rubber, fabrics, seals, and metal. Although the adhesive remains pliable it is still resistant to the elements, detergents, grease, and more. Choice of black or yellow adhesive. 5 oz. tube.

96-8008-296 (BLACK)

96-8001-96 (YELLOW)

*State of California Only WARNING:

Products with an asterisk (*) can expose you to chemicals including toluene which is known to the State of California to cause cancer or birth defects or other reproductive harm.

For more information, visit www.P65Warnings.ca.gov

3M Weatherstrip Adhesive Black (5 oz.)*



This Black Weatherstrip Adhesive is designed to bond weatherstrip and seals to other rubber parts and specifically to EPDM rubber. This adhesive is ideal for door, trunk, t-top, and sunroof weatherstripping. This adhesive creates a permanent bond when used on rubber, fabrics, vinyl, and metal. Although the adhesive remains pliable it is still resistant to the elements, oil, grease, and solvents. 5 oz. tube.

96-8011-296

Loctite Super Bonder 495



General purpose instant adhesive designed to bond rubber, metal and plastic parts. Excellent for modified gaskets or rubber footage made of dense or sponge rubber. 3 gm. tube.

96-0495-296

3M Plastic and Emblem Adhesive



An excellent clear adhesive for plastic repair and emblem application. Use this strong, quick-drying adhesive for plastic or metal emblems, interior rigid plastic, tail light lenses, vinyl side moldings or upholstery. 5 oz. tube.

96-8061-296

Call or visit our website for current pricing

Black Windshield and Body Sealant



A flexible Windshield and Body Sealant designed specifically for creating a watertight seal between windshield rubber gaskets and RV bodies.

96-8509-96

3M Rubberized Undercoating*



3M™ Professional Grade Rubberized Undercoating produces a textured finish which resists chipping, abrasion, exterior rusting and weathering. This coating provides one-coat build-up with no dripping, running or sagging. The undercoating is excellent for automotive undercarriages and for other uses including protection for wheel wells, fenders, quarter panels and more.

96-3584-96

3M Adhesive Remover - Low VOC



3M Adhesive Remover - Low VOC is ideal for helping dissolve and remove dirt, grease, tar, and many non-curing type adhesives. Cleans without streaking and has proven to be excellent for surface preparation in adhesive applications. While this multipurpose cleaner is suitable for industrial use, it's also safe enough for everyday projects.

96-3618-96

Call or visit our website for current pricing

***State of California Only** **WARNING:**

Products with an asterisk (*) can expose you to chemicals including toluene which is known to the State of California to cause cancer or birth defects or other reproductive harm. For more information, visit www.P65Warnings.ca.gov

3M Urethane Adhesive*



3M™ Auto Glass Urethane Windshield Adhesive is a medium viscosity, one-part, moisture-curing urethane adhesive. It is formulated to be fast-curing and non-sagging for rapid results and a clean and simple application process. The features of this adhesive produce a high-strength bond and is ideal for mounting vehicle windshields, backlights, sidelights, and even beltline windowfelts.

96-8693-96

Trim Pad Removing Tool



Removes reveal moldings on rubber-less jobs. 9.5" long.

94-0108-94

Panel Clip Retainer Removal Tool



For removing clips and retainers quickly and easily. Simply seat the tool on the shaft of the fastener and squeeze the molded handles

94-0101-94

All Purpose Tool



An all purpose tool with an extra long hook. Use to remove moldings, body clips, windshield seals, cotter pins and radiator hoses. Made of tough spring steel, heat treated, tempered and plated. 8 inches long, 4.875 inch blade with 2 inch hook.

94-0102-94

Ball End Hook Tool



This Ball End Hook Tool assists greatly in the installation of window rubber on classic collector vehicles. This hook tool has a small, round steel ball on the end. Once the steel ball is inserted down into the rubber gasket, it is very difficult for it to come out. With the ball end design, should the tool indeed slip out of the gasket, there is less of a chance you will scratch the paint of the vehicle.

94-0101-94

Mini Hook Tool Set



This Mini Hook Tool Set offers four (4) different configurations to help you get under and pry up the smallest object.

94-0068-94

Glass Retainer Clip Tool



Reduces the risk of chips and scratches to glass windows caused by makeshift tools. This tool is specifically designed to fit trim clips over the studs and virtually eliminates glass breakage. It also dispenses with the need to remove rubber-like sealant surrounding the studs. A practical tool for placing trim retainer clips over headed studs welded around the body window shields.

94-0106-94

Call or visit our website for current pricing

Steele Branded Safety Glasses



Reinforced plastic, clear lenses and wraparound frame.

94-0109-94

Scraper/Tuck Tool



This handy tool is great for scraping off old glue and prepping surfaces without damaging metal. Also can be used to help tuck rubber which makes replacing windshield gaskets easier. A good multi purpose tool.

Measures: 7-3/4" by 5/8"

94-0110-294

Weatherstrip General Installation Kit



This Weatherstrip General Installation Kit has the items generally needed for the completion of a weatherstrip project. These kitted products are those chosen by the best professional builders and installation specialists in the restoration industry. We've put everything together in one simple and convenient kit.

KIT INCLUDES:

- 1 ea. 3M Weatherstrip Adhesive Black 96-8008-96
- 1 ea. Loctite Super Bonder 495 96-0495-96
- 1 ea. 3M Adhesive Cleaner 96-8987-96
- 1 ea. Scraper / Tuck Tool 94-0110-00
- 1 roll 1-1/2" Masking Tape 96-3431-96
- 3 pr. Nitrile Disposable Gloves
- 2 ea. Adhesive Applicator Sticks
- 1 ea. Steele Rubber Products Decal

90-3355-290

SCREW-TRACK COVERS

Steele Rubber Products screw-track covers are great for covering a row of open screws or rivets. They can also be used to cover a line where two panels meet. The domed version 70-4119-265 accommodates larger hardware or could conceal properly insulated wiring and cables.

Part# 70-4120-265 must be used as a base for each.

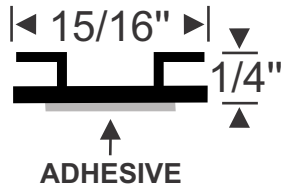

70-4120-265 • per/ft.



FLAT

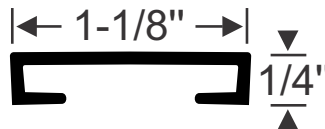

70-4118-265 • per/ft.



DOMED

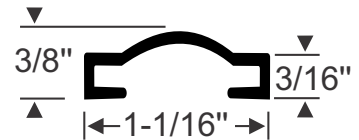

70-4119-265 • per/ft.

SLIDE ON BULB SEALS

The Track Channel 70-4120-265 is the base for many of our slide-out seal products. By itself, this track may be used in combination with any of the four bulb-and-track combinations shown here to supplement your existing sealing arrangements. Likewise, this combination can be used anywhere else you need a robust and serviceable seal design.

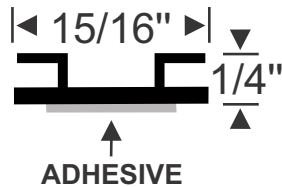

70-4120-265 • per/ft.

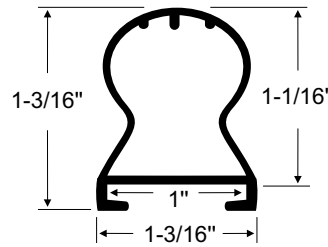

70-3834-265 • per/ft.

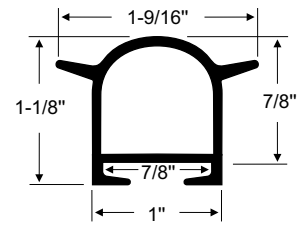

70-3969-265 • per/ft.

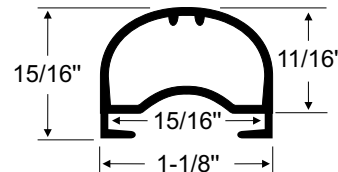

70-3882-265 • per/ft.

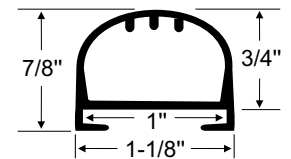

70-3833-265 • per/ft.



CREATE YOUR OWN CUSTOM SEAL

FLAT SCREW TRACK COVER ALSO ALLOWS THE CREATION OF YOUR OWN CUSTOM SEAL!

By utilizing our part# 70-4120-265 & flat track # 70-4118-265 you can add any of our Peel-N-Stick extrusions on top. This creates a custom seal for a variety of applications.

PRESS-IN SCREW TRACK COVERS

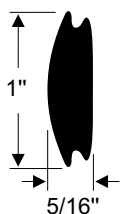

70-4063-240 per/ft.

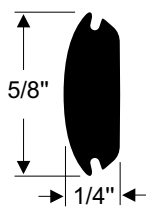

70-4070-240 per/ft.

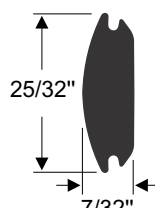

70-4071-240 per/ft.

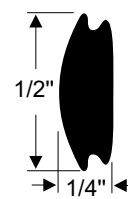

70-4754-240 per/ft.

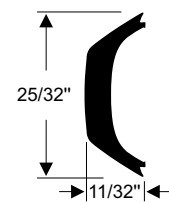

70-4069-240 per/ft.

Peel-N-Stick Instructions

Easy to Install . . .



**Weatherstripping From
Steele Rubber Products**



"No messy glue, just peel and stick!"

Steele Rubber Products Peel-N-Stick parts featuring 3M's bonded adhesive are easy to install and provide long lasting protection.

Instructions:

- 1. Examine New Seal-** Please examine the Peel-N-Stick parts in the package to ensure they meet your expectations prior to installation. If the part has any defects, please contact us directly. We cannot accept returns of Peel-N-Stick parts that have been cut or altered.
- 2. Clean Surface-** Before installing the part, the application surface must be clean and free of adhesive residue, grease, old seals or wax. Rubbing alcohol is recommended as a means to ensure a properly prepared surface. Be sure to allow the alcohol to dry prior to installing the new Peel-N-Stick weatherstripping.
- 3. Cut To Size-** If necessary, cut the weatherstrip to length using sharp scissors or a knife. A colored marker may be used to note where to cut the seal. For best results, compress the material while cutting to ensure a straight and uniform edge.
- 4. Installation-** When installing the part, start at one end and slowly peel back the red tape in short lengths. Firmly press the weatherstripping onto the surface. Note: Once applied, damage to the weatherstripping or adhesive failure could occur if an attempt is made to remove and re-apply it.



MITERING CORNERS

1. Mark a 45 degree line from the corner edges of the ramp gate. Laying the seal across the corner, mark the outside edge of the seal where it intersects that line.
2. Using the corner of a piece of paper, carefully mark a right angle on the seal starting from the intersection line. (Figure 1)
3. Trim the seal along the marked lines, however, DO NOT cut all the way through the seal leaving the outside edge holding the seal together. (Figure 2)
4. Carefully apply the **Super Bonder 495** to one side of the cut edges and fold the seal together to form a 90 degree corner. (Figure 3)



FIGURE 1

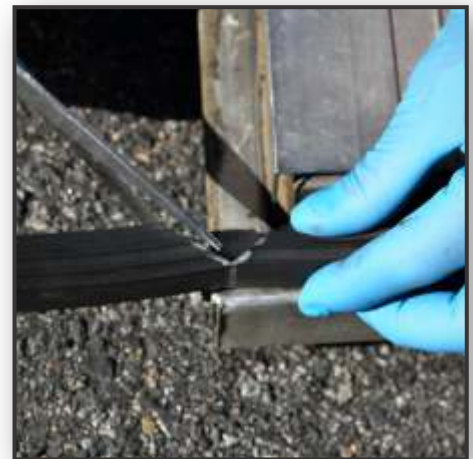

FIGURE 2

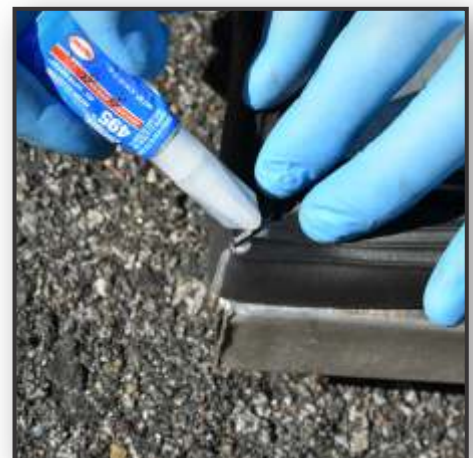
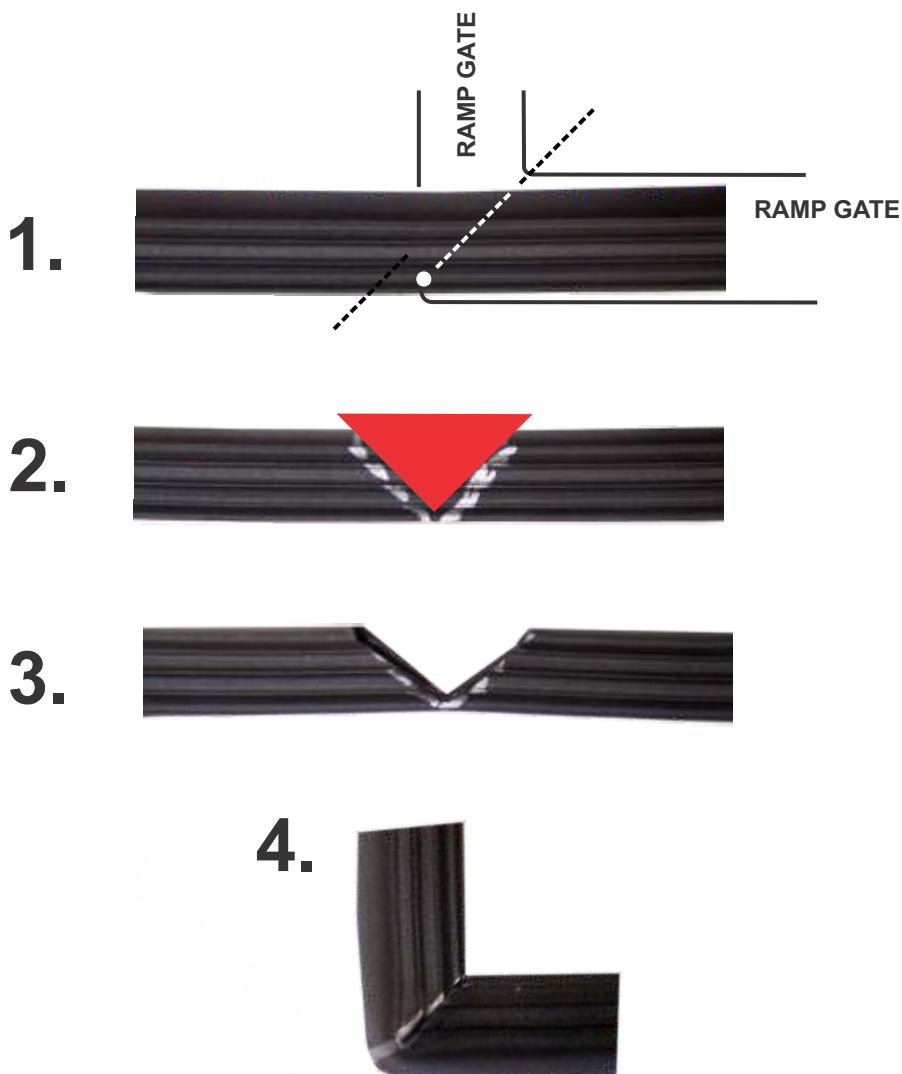

FIGURE 3





“How To” Videos

Check out our “How To” videos!

Need help installing your RV weatherstripping?
Visit our YouTube channel and we'll show you how to do it.

Whether you are replacing a slide-out seal or entry door weatherstripping, our “How To” videos will get you started in the right direction.

Visit www.youtube.com/steelerubberproducts



Slide-Out Seal Replacement



Front Door Seal Replacement



steelerubber.com/install
youtube.com/steelerubberproducts

CONTACT US

ONLINE - CHAT
STEELERUBBER.COM

TOLL FREE
800-230-5897

EMAIL
rv@steelerubber.com



CUSTOMER SERVICE

Steele provides quality service both before and after your purchase. To place orders, check order status, request a catalog or for any other inquiries, contact us Mon-Friday 8am-6pm Eastern Standard Time at 800-230-5897 (toll free) or 704-483-9343 (local). You can also contact us 24/7 at contact@steelerubber.com.

RETURN POLICY

In the event that you need to return any products, contact us directly Monday-Friday 8am-6pm at 800-461-7089 (toll free) or 704-483-9343 (local) and our Customer Service Representatives will provide you with a return merchandise authorization number (RMA) and instructions for returning any part(s) to us.

Note:

Parts are accepted for return only in the units purchased and with the original invoice. We cannot accept refund packages sent COD or any method for which there is a charge to us. If a part is altered or damaged in any way, we will not be able to accept it for return. We cannot accept returns of products not purchased directly from Steele Rubber Products. Shipping and handling charges are not refundable. To view our full return policy visit: steelerubber.com/returns

PARTS AVAILABILITY

New parts are constantly added to our inventory. Visit us online for current availability of all products.

DELIVERY OF PARTS

We cannot guarantee a continuous roll of any extrusion in this catalog when ordered in bulk. We will do our best to ensure that each strip is as long as possible to minimize scraggage for you. Therefore, we reserve the right to deliver your parts in multiple lengths to meet your total purchase requirements.

USE OF PARTS

These parts are replacement options and not factory-original products. We are not responsible for damages caused by incorrect installation, abuse, mishandling, accidents or normal wear. Nor will Steele be responsible for labor charges, inconveniences, or any other expenses associated with parts bought through resellers or Steele.

SATISFACTION GUARANTEE

We offer a 100% satisfaction guarantee on all parts manufactured by and purchased from Steele Rubber Products.

COPYRIGHT SECTION

Contents 2024© Steele Rubber Products, Inc. Printed in the USA. This catalog may not be reproduced without written permission. All drawings, photographs, and graphic images contained in this catalog are the property of Steele Rubber Products and cannot be reproduced without written permission. The contents of this catalog should not be altered in any way for commercial or other use.

PAYMENT INFORMATION

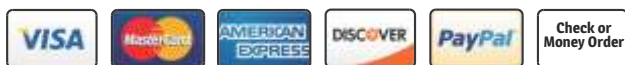

For full disclosure of Steele Rubber Products policies please visit us online at steelerubber.com/refunds. If you do not have access to the internet and would like a printed version of our policies, please call 800-230-5897 (toll free) or 704-483-9343 (local).



Please visit our website for the most up-to-date product information.



SINCE 1958

Steele Rubber Products
6180 E. NC 150 HWY
Denver, NC USA 28037

Toll Free 800-230-5897
STEELERUBBER.COM

REVISED
8/29/24