



Street Rod Catalog

Quality Crafted Rubber Seals and Parts



- Door Weatherstripping
- Window & Glass Seals
- Trunk Weatherstripping
- Peel-N-Stick Extrusions
- Hood Seals & Bumpers
- Body Mounting Pads
- Rubber Bushings
- Fuel, Clutch & Brake Parts
- Bumpers, Grommets, Plugs
- Adhesives & Cleaners

SINCE 1958



THIS IS YOUR STREET ROD CATALOG

Thank you for trusting Steele Rubber Products with the protection of your Street Rod.

Here at Steele Rubber Products, we've been making quality crafted rubber parts and weatherstripping since 1958. We're a family run business now in its third generation and we continue to proudly manufacture in the United States!

Our goal is to provide you the best quality and fitting seals and weatherstripping available on the market. Learn more about us and everything we offer by visiting our website at steelerubber.com.

HOW TO USE THIS CATALOG

We've done a lot of research to make this catalog easy to use and it's designed to help you find what parts you need. Grouped into specific categories, each part is presented with a profile silhouette and exact dimensions to help you identify the correct shape and size, ensuring the best fit.

We are so determined in finding you the best solution, we even offer samples of our seals before you make the decision to buy. If at any time you need assistance, our team of Product Specialists are here to help.



HOW TO ORDER

GO TO STEELERUBBER.COM

SEARCH FOR
PART NUMBER

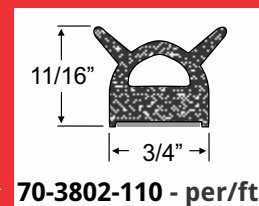

OR CALL

800-650-6190

8am-6pm Eastern

CONTACT US

EMAIL

cars@steelerubber.com

MAIL

6180 E NC 150 HWY
DENVER, NC 28037

Table Of Contents



DOOR COMPONENTS

PAGES 2-5

WINDOW & GLASS

PAGES 6-11

TRUNK & RUMBLESEAT

PAGES 12-13

COWL & HOOD COMPONENTS

PAGES 14-15

BODY & FENDER

PAGES 18-21

BRAKE & CLUTCH COMPONENTS

PAGES 22-23

FUEL SYSTEM COMPONENTS

PAGES 24-26

INTERIOR COMPONENTS

PAGES 27-28

GROMMETS - BUMPERS - PLUGS

PAGES 29-31

ADHESIVES - CLEANERS - TOOLS

PAGES 32-35

steelerubber.com



Door Weatherstripping



Peel-N-Stick Door Seals





Our Peel-N-Stick weatherstripping can be used any place a rubber seal is needed. With the easy to use Peel-N-Stick adhesive backing, simply cut to size and apply to the areas you need to seal. Available in multiple lengths and in a variety of profiles, our Peel-N-Stick parts are made of the same quality sponge & dense rubber found in our standard rubber parts and weatherstripping.

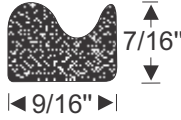
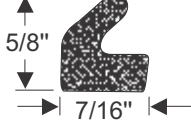
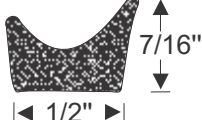

Call or visit our website for current pricing

<p>70-4264-110 • per/ft.</p>	<p>70-3846-110 • per/ft.</p>	<p>30-0144-110 • per/ft.</p>	<p>70-4205-110 • per/ft.</p>	<p>70-4204-110 • per/ft.</p>
<p>70-4756-354 • per/ft.</p>	<p>70-0390-110 • per/ft. AVAILABLE AS GLUE-ON</p>	<p>40-0480-110 • per/ft. AVAILABLE AS GLUE-ON</p>	<p>70-0331-110 • per/ft. AVAILABLE AS GLUE-ON</p>	<p>70-0145-110 • per/ft. AVAILABLE AS GLUE-ON</p>
<p>70-2087-110 • per/ft.</p>	<p>70-2117-110 • per/ft.</p>	<p>70-2086-110 • per/ft.</p>	<p>70-3676-110 • per/ft.</p>	<p>70-3849-110 • per/ft.</p>
<p>70-2084-110 • per/ft.</p>	<p>70-2088-110 • per/ft.</p>	<p>70-2132-110 • per/ft.</p>	<p>70-3847-99 • per/ft.</p>	<p>70-3852-110 • per/ft.</p>
<p>70-2088-110 • per/ft.</p>	<p>70-2132-110 • per/ft.</p>	<p>70-3847-99 • per/ft.</p>	<p>70-3852-110 • per/ft.</p>	<p>70-2431-110 • per/ft.</p>

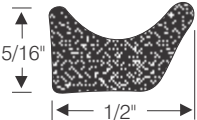
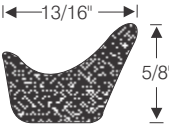
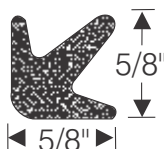
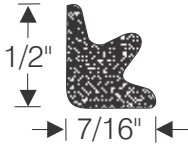
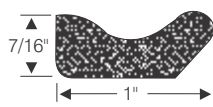
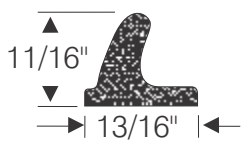
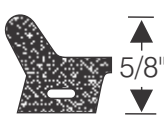
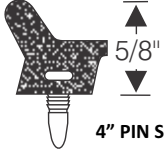
Glue-On Door Seals

 <p>70-0390-109 • per/ft. AVAILABLE AS PEEL-N-STICK</p>	 <p>40-0480-109 • per/ft. AVAILABLE AS PEEL-N-STICK</p>	 <p>70-0331-109 • per/ft. AVAILABLE AS PEEL-N-STICK</p>	 <p>70-0145-109 • per/ft. AVAILABLE AS PEEL-N-STICK</p>	 <p>70-1789-109 • per/ft.</p>
 <p>50-0085-109 • per/ft.</p>	 <p>70-0219-109 • per/ft.</p>	 <p>70-0311-109 • per/ft.</p>	 <p>30-0470-109 • per/ft.</p>	 <p>70-0491-109 • per/ft.</p>
 <p>70-1111-109 • per/ft. GLUE-ON</p>	 <p>70-1112-109 • per/ft. PRESS-ON WITH PINS 4" PIN SPACING</p>	<p>For Glue-On Door Seals, we only use 3M products!</p>  <p>3M Super Weatherstrip Adhesive Black or Yellow (5 oz.)*</p> <p>96-8008-110 (BLACK) 96-8001-110 (YELLOW)</p>		

Press-On Door Seals

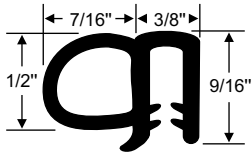
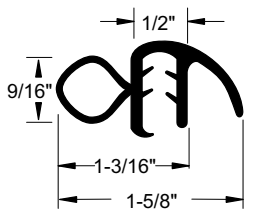
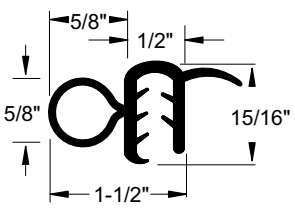
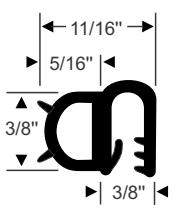
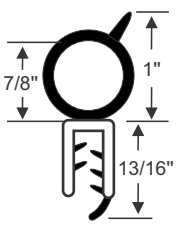
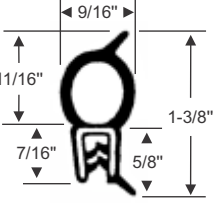
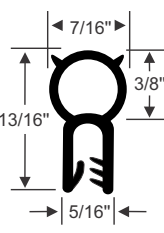
 <p>Fits flanges up to 1/8" 70-3584-140 • per/ft.</p>	 <p>Fits flanges up to 1/8" 70-3592-140 • per/ft.</p>	 <p>Fits 1/4" flanges 70-4144-140 • per/ft.</p>	 <p>Fits flanges 1/8" to 3/16" 70-2734-140 • per/ft.</p>
 <p>Fits flanges 3/64" to 1/8" 70-3855-140 • per/ft.</p>	 <p>Fits flanges 7/64" to 1/8" 70-2831-140 • per/ft.</p>	 <p>Fits flanges up to 1/16" 70-3590-140 • per/ft.</p>	 <p>Fits flanges 3/16" to 1/4" 70-3854-140 • per/ft.</p>

Door Bumpers



Door Bumpers

Steele Rubber Products offers the best quality Door Bumpers for your Street Rod or Custom Build project. Excellent also for use in many other applications. These bumpers are commonly found in the door opening or on the door itself.

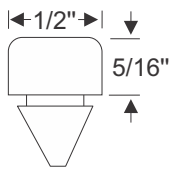

FITS 1/4" HOLE
33-0136-108

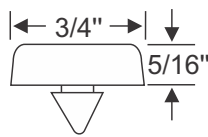

FITS 1/4" HOLE
33-0046-108

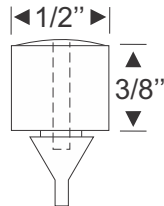

FITS 1/4" HOLE
33-0496-108

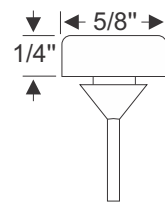

FITS 1/4" HOLE
33-1574-108

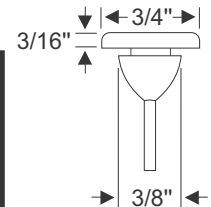

FITS 5/16" HOLE
33-0113-108

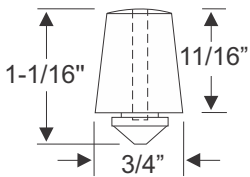

FITS 5/16" HOLE
33-0293-108

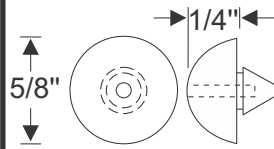

FITS 1/4" HOLE
33-0211-108

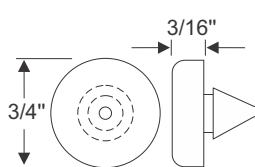

FITS 1/4" HOLE
33-0459-108

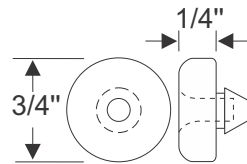

FITS 5/16" HOLE
33-0109-108

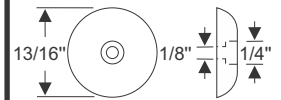

HELD BY SCREW/BOLT
34-0131-108

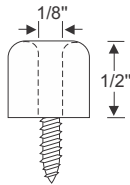

SCREW INCLUDED
34-0484-108

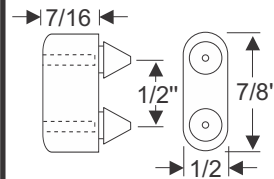

33-1227-108

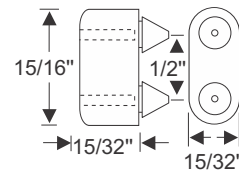

70-1839-108

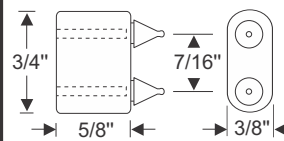

70-2615-108

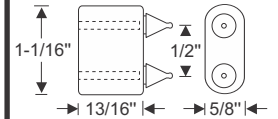

33-0981-108

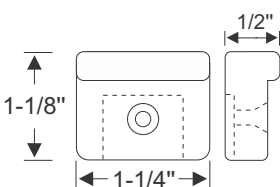

40-0010-108

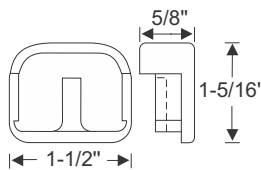

70-1156-108

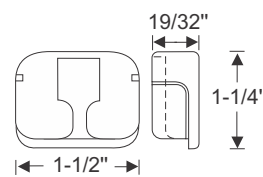

70-1159-108



SINCE 1958



Door Handle & Lock

Door handles and door locks are one of the most prominent components as far as providing a finished look to your Street Rod or Custom Build project. We offer a wide variety of door handle gaskets, door handle ferrules, door handle ferrule grommets, lock cylinder gaskets, and door lock knobs. For help finding the right part for the job, call 800-650-6190



Door Handle Gaskets

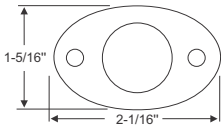

20-2103-108 • pr.

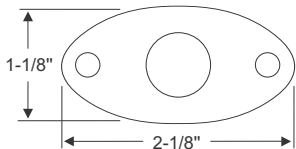

20-2105-108 • pr.

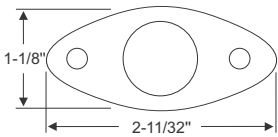

20-2101-108 • pr.

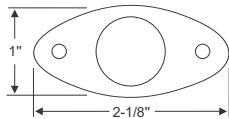

20-2238-108 • pr.

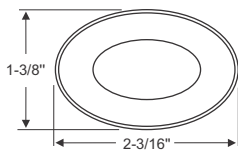

20-0478-108 • pr.

Door Handle Grommets

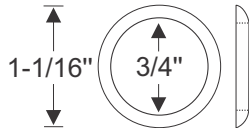

70-0173-108 • ea.

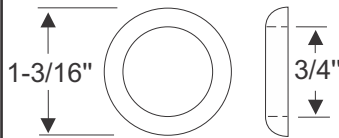

70-0009-108 • ea.

Door Lock Cylinder Gasket

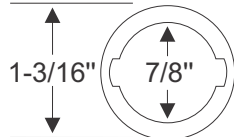

60-0641-108 • ea.

Door Handle Pressure Ring

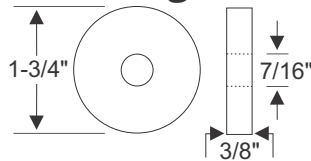

70-0261-108 • ea.

Door Handle Grommet with Chrome Ring 2 Piece Set

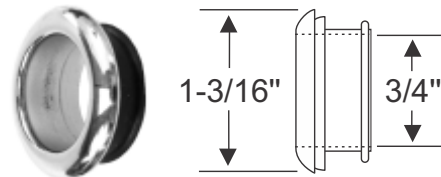

Chrome Ferrule Rubber Grommet

60-0389-108 • set

Door Lock Button Grommets

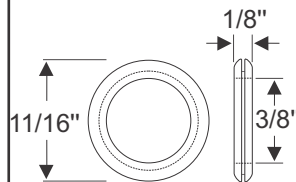

20-2589-108 • ea.

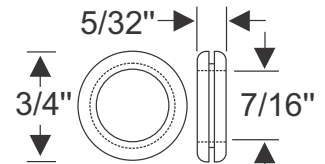

30-0533-108 • ea.

Door Lock Knobs

BLACK

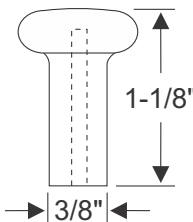

30-0251-108 • ea.

BROWN

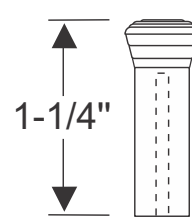

70-0660-108 • ea.

BROWN

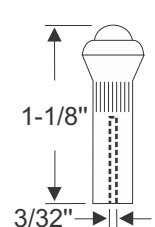

70-0354-108 • ea.

WINDOW & GLASS SEALS



Windshield & Rear Glass Rubber

When considering changing the windshield weatherstrip for your Street Rod or Custom Build project, look no further than our complete selection of high-quality seals. Our inventory includes window edge trims, window locking gaskets, universal locking keys, t-rubber for glass trims, and more. Need assistance finding the right part for the job? Call 800-650-6190

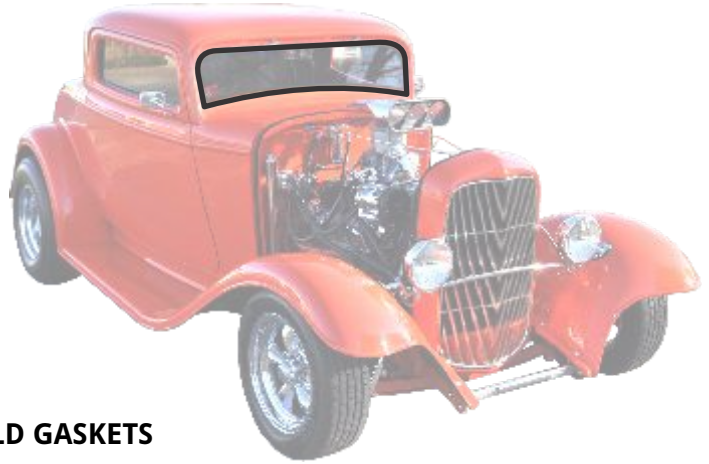

ASK ABOUT OUR VEHICLE SPECIFIC WINDSHIELD GASKETS

<p>1/4" 9/16" 1/2"</p> <p>70-0084-119 • per/ft.</p>	<p>7/32" 5/8" 5/8"</p> <p>70-1194-119 • per/ft.</p>	<p>7/32" 7/16" 7/16"</p> <p>30-0044-119 • per/ft.</p>	<p>1/4" 1/2" 5/8"</p> <p>30-0478-119 • per/ft.</p>	<p>7/32" 5/8" 7/8"</p> <p>70-1192-119 • per/ft.</p>
<p>7/8" 5/8" 7/32"</p> <p>70-1188-119 • per/ft.</p>	<p>5/8" 1/2" 7/32"</p> <p>30-0086-119 • per/ft.</p>	<p>7/8" 5/8" 1/4"</p> <p>70-1191-119 • per/ft.</p>	<p>9/16" 5/8" 1/4"</p> <p>70-1195-119 • per/ft.</p>	<p>11/16" 9/16" 1/4"</p> <p>40-0359-119 • per/ft.</p>
<p>7/8" 5/8" 7/32"</p> <p>70-1190-119 • per/ft.</p>	<p>3/16" 11/16" 1"</p> <p>70-2860-119 • per/ft.</p>	<p>5/8" 1/4" 1"</p> <p>60-0083-119 • per/ft.</p>	<p>9/32" 5/8" 1-1/8"</p> <p>50-0333-119 • per/ft.</p>	<p>5/8" 1-1/8" 1/4"</p> <p>60-0661-119 • per/ft.</p>
<p>7/16" 1/4" 7/8"</p> <p>19-0006-119 • per/ft.</p>	<p>13/16" 1/4" 1/2" 15/16"</p> <p>60-0038-119 • per/ft.</p>	<h3>For Swingout Windshields</h3>		
		<p>5/16" 3/4"</p> <p>40-0036-119 per/ft.</p>	<p>1/4" 5/8"</p> <p>40-0033-119 per/ft.</p>	<p>5/16" 13/16"</p> <p>40-0018-119 per/ft.</p>



Windshield & Rear Glass Seals with Locking Strip

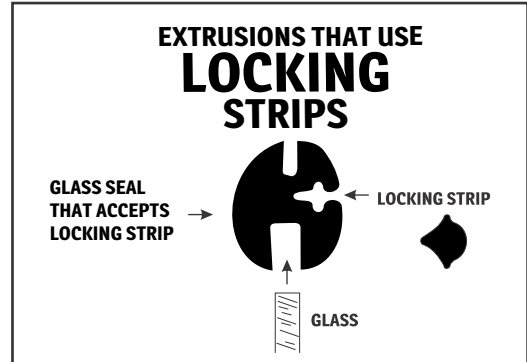

EXTRUSIONS

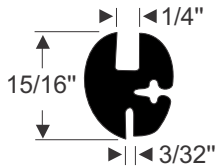

60-0082-119 • per/ft.

USES 60-0607-119 LOCKSTRIP

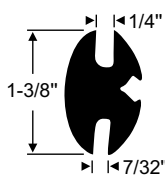

70-4299-119 • per/ft.

USES 60-0607-119 LOCKSTRIP

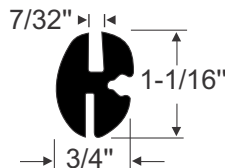

40-0496-119 • per/ft.

USES 30-0439-119 LOCKSTRIP

LOCKING STRIPS



60-0607-119 • per/ft.



30-0439-119 • per/ft.

"T" Glass Seals

T-Rubber Window Weatherstrip is commonly used for windshields, rear windows where the rubber is held in place with a track or channel.

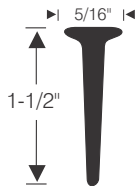

19-0024-119 per/ft.

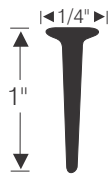

70-1163-119 per/ft.

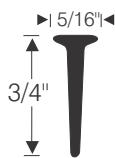

70-0142-119 per/ft.

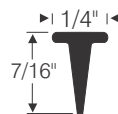

19-0023-119 per/ft.

FLUSH MOUNT

These extrusions are designed to sandwich between the edges of the vehicle body and glass on flush mount installations. Ideal for use on Street Rods and Customs to flush mount the windshield and or rear glass.

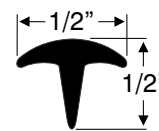

70-4155-119 • per/ft.
70-4159-119 • 12ft.

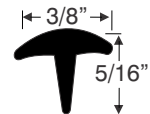

70-2841-119 • per/ft.
70-2851-119 • 12ft.
70-2850-119 • 20ft.

Universal Windshield Divider Bars

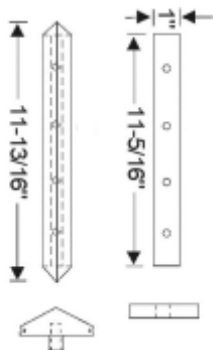

50-0301-108 • set.

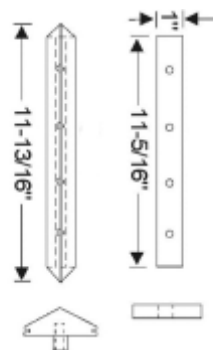

70-00159-108 • set.

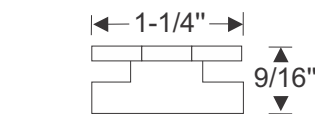

70-0372-119 • 16-1/2" Strip

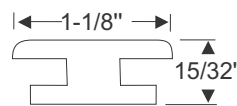

70-0098-108 • 16-1/2" Strip

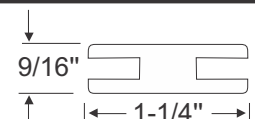

40-0514-119 • per/ft.

QUARTER WINDOW SEALS



QUARTER WINDOW SEALS

Also known as Quarter Window Leading Edge Seals, they are common in many Street Rod or Custom Builds. Keep your quarter windows sealed tight with our high-quality universal leading edge weatherstrips. Need assistance finding the right part for the job? Call 800-650-6190



Quarter Window Slide-In type

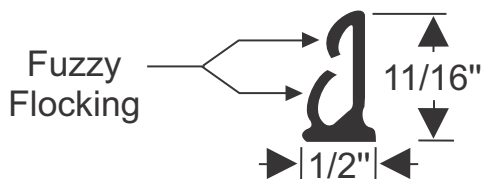

70-1556-130 - (2) 18" Strips

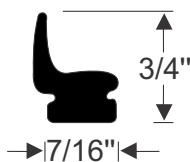

70-0141-119 - (2) 16-1/4" Strips

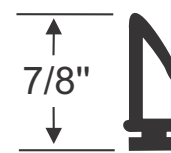

50-0428-119 - (2) 16-1/2" Strips

Quarter Window Glue-On type

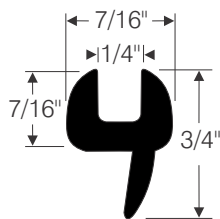

19-0005-119 - per/ft.

Call or visit our website for current pricing

ASK ABOUT OUR VEHICLE SPECIFIC QUARTER WINDOW SEALS

Rear Quarter Window Seal - For older Street Rods

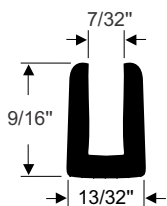

20-2122-119 - 122" Strip



Window Felts & Beltline

Window felts and beltlines are essential components to guarantee a smooth window function. We have a complete inventory for your Street Rod or Custom Build project - ranging from window sash/beltline channel, outer beltline weatherstrip, dense window beltline, flocked sponge window beltline, and more. Need assistance finding the right part for the job? Call 800-650-6190



Call or visit our website for current pricing

<p>70-0755-108 (2) 38" strips</p>	<p>70-0961-135 - (2) 48" strips</p>	<p>30-0244-135 - (2) 36" strips 70-3816-135 - (2) 24" strips</p>	<p>40-0540-135 - 6' strip 40-0539-135 - (2) 36" strips 70-3817-135 - (2) 24" strips</p>	<p>70-0555-58 two 3' strips 70-0353-78 - 6' strip</p>
<p>30-0300-135 (2) 36" strips 70-3866-135 (2) 24" strips</p>	<p>30-0301-135 - (2) 36" strips 70-3815-135 - (2) 24" strips</p>	<p>70-0749-135 - (2) 36" strips 70-3818-135 - (2) 24" strips</p>	<p>70-0651-135 - 6' strip</p>	<p>70-1121-134 (2) 36" strips 70-1120-134 - 6' strip</p>
<p>70-3807-135 two 4' strips</p>	<p>70-3804-135 two 4' strips</p>	<p>70-3805-135 two 4' strips</p>		
<p>PEEL-N-STICK</p> <p>70-2820-120 - 5' strip 70-2821-120 - 10' strip 70-2822-120 - 15' strip</p>	<p>PEEL-N-STICK</p> <p>70-2816-120 - 5' strip 70-2817-120 - 10' strip 70-2818-120 - 15' strip</p>	<p>PEEL-N-STICK</p> <p>Sponge Rubber with Fuzzy Flocked Coating</p> <p>70-2813-120 - 5' strip 70-2814-120 - 10' strip 70-2815-120 - 15' strip</p>	<p>PEEL-N-STICK</p> <p>Fuzzy Flocked Surface</p> <p>70-4062-110 - per/ft.</p>	

WINDOW RUN CHANNEL



Rubber Run Channel with Fuzzy Flocking

Designed with flexibility in mind, these pre-flocked rubber run channels provide a smooth sliding surface for glass movement on your Street Rod or Custom Build. These seals are great for use in door, quarter window, and tailgate glass windows. Need assistance finding the right part for the job? Call 800-650-6190



Call or visit our website for current pricing

<p>FLOCKED</p> <p>70-0306-130 • per/ft</p>	<p>FLOCKED</p> <p>70-1168-130 • per/ft</p>	<p>FLOCKED</p> <p>70-1169-130 • per/ft</p>	<p>70-3572-130 • 8' strip</p>	<p>70-3576-130 • 6' Strip</p>
<p>70-3579-130 • 8' strip</p>	<p>70-3578-130 • 8' strip</p>	<p>70-3570-130 • 8' strip</p>	<p>70-3575-130 • 8' strip</p>	<p>70-3577-130 • 8' strip</p>
<p>60-0583-130 - 8' strip</p>	<p>70-3580-130 • 8' strip</p>			
<p>70-3571-130 • 8' strip</p>				

Flexible & Rigid Run Channel with Metal Core

Flexible & Rigid run channels provide a smooth sliding surface for door, quarter window, and tailgate glass windows on your Street Rod or Custom Build. Designed with a flexible or rigid metal core, these run channels come mohair lined and the flexible ones are cloth covered. Need assistance finding the right part for the job? Call 800-650-6190

Flexible Run Channel

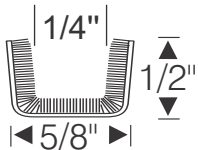

FLEXIBLE METAL SPINE
70-1107-135 - 5' strip
70-1108-135 - 6' strip

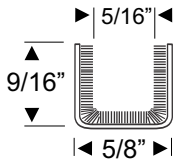

FLEXIBLE METAL SPINE
20-1619-135 - 5' strip
40-0309-135 - (2) 3' strips
40-0309-136 - 8' strip

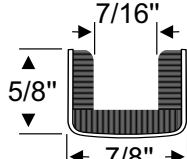

FLEXIBLE METAL SPINE
60-0375-135 - 5' strip
60-0129-135 - 90" strip

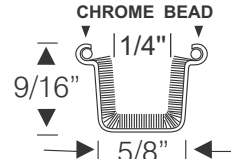

FLEXIBLE METAL SPINE
70-1238-135 - 5' strip
70-1239-135 - 6' strip

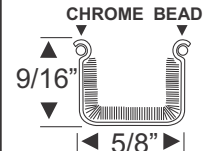

FLEXIBLE METAL SPINE
20-1146-135 - 5' strip

Rigid Run Channel

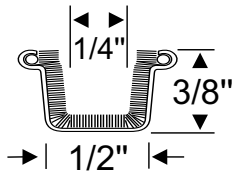

70-0536-135
(2) 29" strips

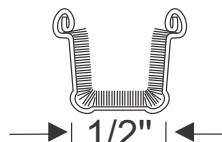

70-0516-135
(2) 15" strips

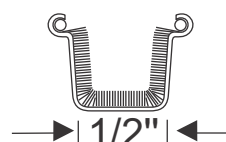

70-0347-135
(2) 15" strips



30-0023-135
(2) 28" strips

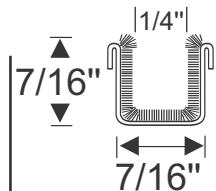

70-0752-135 - 6' strip
70-3819-135
(2) 2' strips

Glass Sash Channel Weatherstrip

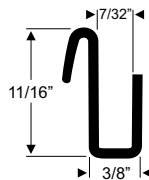

20-2091-119 - 36" Strip

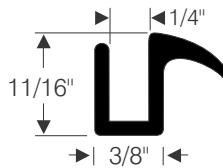

70-0075-119 - per/ft.

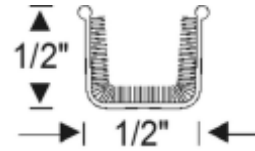

30-0180-135 - (2) 30" strips

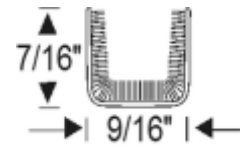

30-0245-135
(2) 30" strips

Glass Sash Channel Fillers

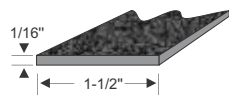
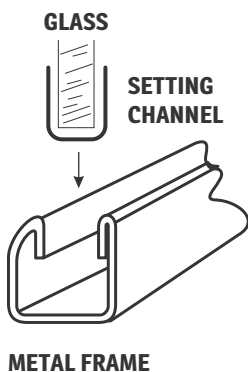

SETTING CHANNEL - CORK
70-1115-119 - per/ft.



SETTING CHANNEL - RUBBER
70-2169-119 - per/ft.

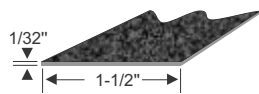

SETTING CHANNEL - CORK
70-1114-119 - per/ft.

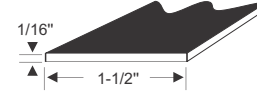

SETTING CHANNEL - RUBBER
70-2170-119 - per/ft.

UNIVERSAL PEEL-N-STICK GLASS WEATHERSTRIPPING



ADHESIVE BACKED
70-4727-115 - 25ft.
70-4716-115 - 75ft.

PERFECT FOR USE AS BELTLINE WEATHERSTRIP

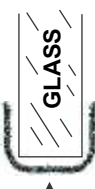
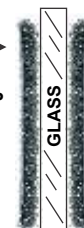

OR FORM AS NEEDED TO CREATE CUSTOM GLASS RUN CHANNEL

TRUNK & RUMBLE SEAT WEATHERSTRIPPING

Our EPDM trunk and rumble seat weatherstripping is perfect for your Street Rod or Custom Build. Our large selection of seals practically guarantee that you will find the right part for your project. For assistance in making your choice, call 800-650-6190



PEEL-N-STICK

<p>70-3848-110 - per/ft.</p>	<p>70-3859-110 - per/ft.</p>	<p>70-3984-110 - per/ft.</p>	<p>70-3802-110 - per/ft.</p>	<p>70-0510-110 - per/ft. *GLUE-ON AVAILABLE</p>
<p>70-0518-110 • per/ft. *GLUE-ON AVAILABLE</p>	<p>70-2085-110 • per/ft. *GLUE-ON AVAILABLE</p>	<p>70-4205-110 • per/ft.</p>	<p>70-4204-110 • per/ft.</p>	<p>70-1106-110 • per/ft. *GLUE-ON AVAILABLE</p>
<p>70-0129-110 • per/ft. *GLUE-ON AVAILABLE</p>	<p>70-1105-110 • per/ft. *GLUE-ON AVAILABLE</p>	<p>30-0243-110 • per/ft. *GLUE-ON AVAILABLE</p>	<p>70-1437-110 • per/ft.</p>	<p>70-2401-110 • per/ft. *GLUE-ON AVAILABLE</p>

*GLUE-ON AVAILABLE

Several of the above profiles are also available as Glue-ON vs. Peel-N-Stick. Don't forget to use our 3M weatherstrip adhesive if you decide to choose the Glue-On option.

3M Super Weatherstrip Adhesive
Black or Yellow (5 oz.)*

96-8008-110 (BLACK)
96-8001-110 (YELLOW)



TRUNK BUMPERS & RUMBLE SEAT BUMPERS

These bumpers absorb shock and reduce the impact from friction and vibration to your Street Rod or Custom Build. We offer a variety of high-quality EPDM dense rubber bumpers for your trunk lid, tailgate, and rumble seat. Need assistance finding the right part for the job? Call 800-650-6190

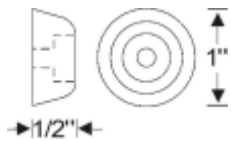

34-0399-108 • ea.



34-0203-108 • ea.

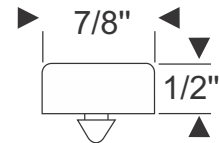

33-0990-108 • ea.

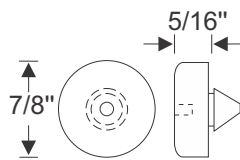

33-0293-136 • ea.



33-0350-108 • ea.

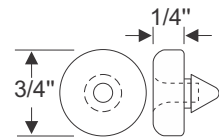

33-0109-108 • ea.

RUMBLE SEAT STEP PADS

Give your Street Rod or Custom Build that finished look with high-quality rumble seat step pads. These pads mount on the taillight stand or fender to protect your paint from scratches while providing a step into the rumble seat. Need assistance finding the right part for the job? Call 800-650-6190

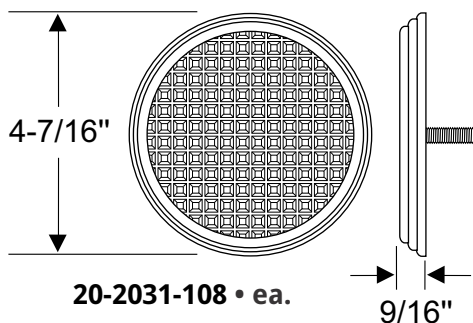

20-2031-108 • ea.

- COWL VENT SEAL
- HOOD TO COWL SEAL
- HOOD TO RADIATOR SEAL

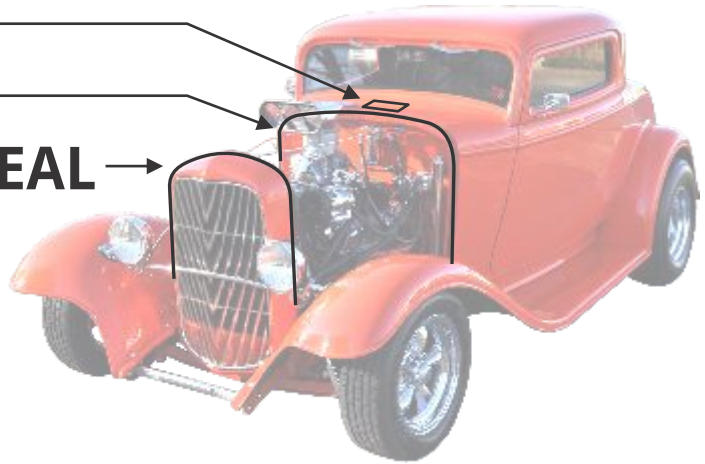

Our Street Rod or Custom Build cowl vent seals offer maximum flexibility to the builder's creative application or use. Also, lift the hood of your street rod with total confidence with these Peel-N-Stick hood to cowl and fabric hood lacing weatherstrippings.

COWL VENT SEALS

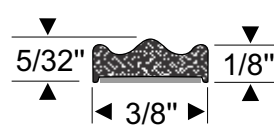

70-4624-110 • per/ft.

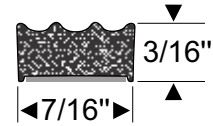

70-3846-110 • per/ft.

ASK ABOUT OUR VEHICLE SPECIFIC COWL VENT GASKETS

HOOD TO COWL/RADIATOR SEALS

PEEL-N-STICK DENSE

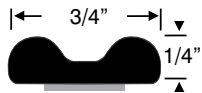

70-2674-110 • 10ft.
70-2675-110 • 15ft.

PEEL-N-STICK SPONGE

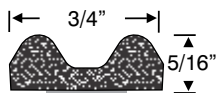

70-2684-110 • 10ft.
70-2685-110 • 15ft.

HOOD LACING - FABRIC MATERIAL

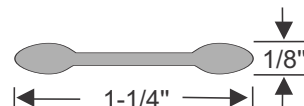

20-0354-115 • 49" Strip

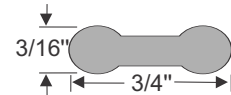

70-2221-115 • per/ft.

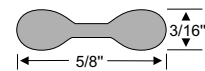

70-4768-115 • per/ft.



60-0578-115 • per/ft.

HOOD BUMPERS - ADJUSTABLE

Used for hood openings to support and cushion the front of the hood. These adjustable hood bumpers and hood bumper caps are a great addition to your Street Rod or Custom build. Made of a high-quality EPDM dense rubber and galvanized or zinc plated steel bolts. Need assistance finding the right part for the job? Call 800-650-6190



TYPICAL ADJUSTABLE HOOD BUMPERS

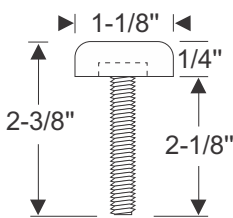

70-1084-108 • pr.
5/16-18 THREAD SIZE

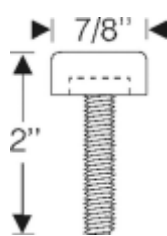

70-0935-108 • pr.
1/4-20 THREAD SIZE

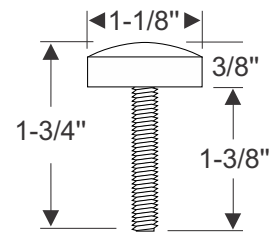

20-2755-108 • pr.
5/16-18 THREAD SIZE

ADJUSTABLE HOOD BUMPER CAPS

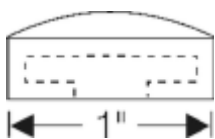

70-1651-108 • ea.

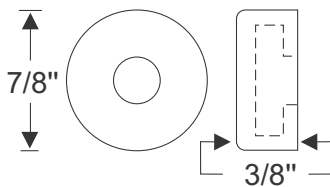

70-0294-108 • ea.

SPRING BUMPERS

Excellent for use in many applications. These Spring Bumpers are for the Builder's creative application and use. Spring Bumpers work to assist in the hood, door, trunk, or tailgate opening and reduce rattles.



70-4736-108 • pr.

HOOD BUMPERS - STEM BUMPER STYLE

Stem bumpers can go a long way in providing a complete look to your Street Rod or Custom Build. We have a wide range of hood bumpers, license plate bumpers, door bumpers, radiator panel bumpers, taillight bumpers, gravel shield bumpers, vent window bumpers, trunk bumpers, inner fender bumpers, and many more. Call 800-650-6190

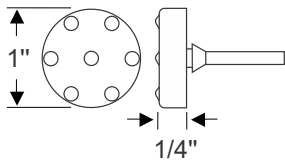
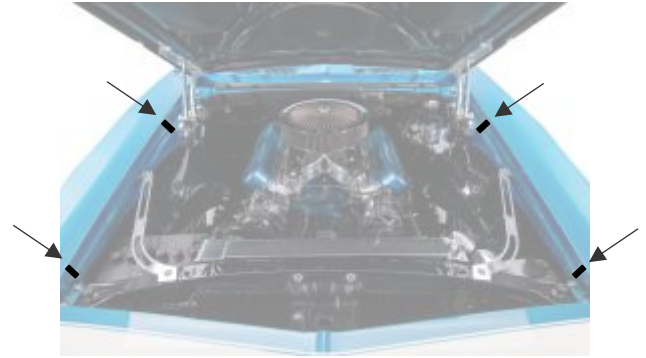

33-0189-108 • ea.

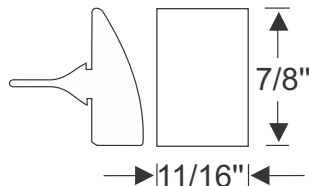

70-1963-108 • ea.

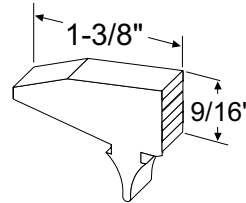

70-3397-108 • ea.

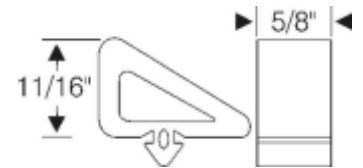

70-1607-108 • ea.

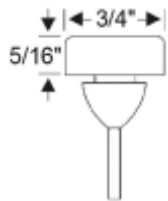

33-0542-108 • ea.

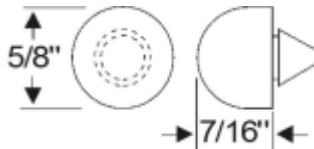

33-0482-108 • ea.

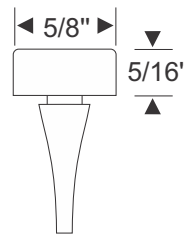

33-0117-108 • ea.

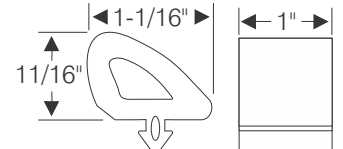

70-1962-108 • ea.

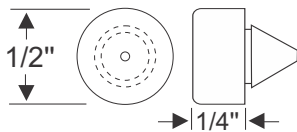

33-0449-108 • ea.

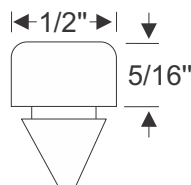

33-0136-108 • ea.

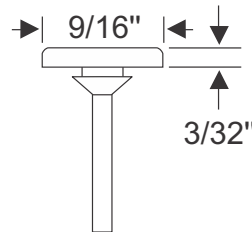

33-0395-108 • ea.

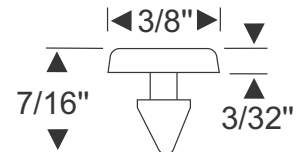

33-0730-108 • ea.

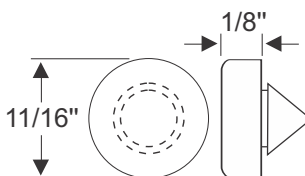

33-0003-108 • ea.

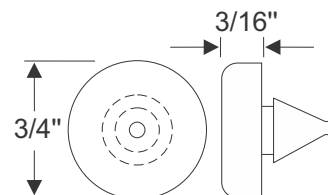

33-0459-108 • ea.

Quality Crafted Rubber Parts And Weatherstripping

“We choose Steele Rubber because their parts are top quality, and they have the largest selection of rubber parts, bar none.”

Kevin Tully & Chad Hill
Hot Rod Chassis & Cycle



Since 1958

800-650-6190
steelerubber.com



BODY MOUNTING PADS

Looking for a smooth ride experience in your Street Rod? Look no further than these high-quality EPDM body mounting pads, body to frame webbings, body bolt cushions, bumper support bar pads, and radiator mounting pads. Need assistance finding the right part for the job? Call 800-650-6190

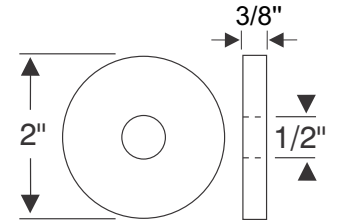

40-0324-108 • ea.

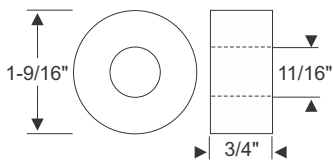

70-2604-108 • ea.

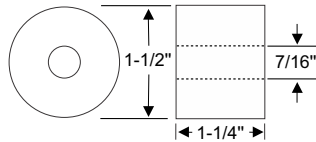

70-0265-108 • ea.

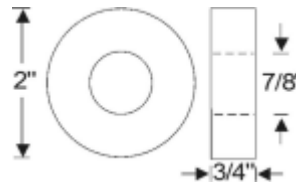

50-0507-108 • ea.

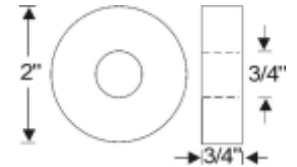

50-0329-108 • ea.

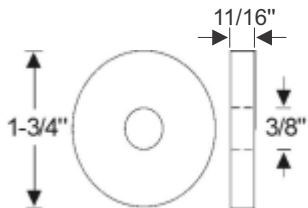

50-0132-108 • ea.

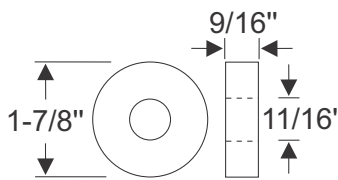

70-2233-108 • ea.

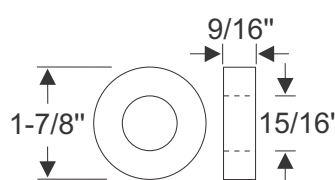

70-2232-108 • ea.

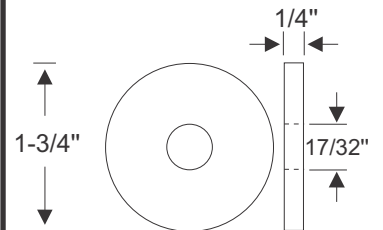

40-0229-108 • ea.

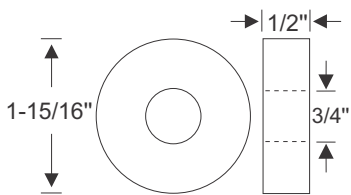

50-0097-108 • ea.

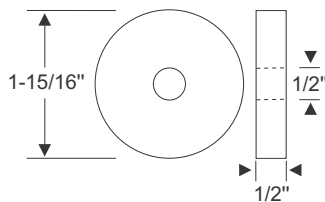

60-0544-108 • ea.

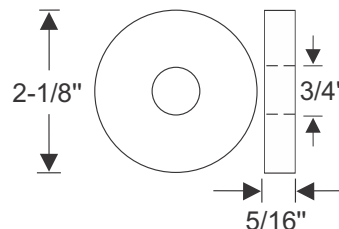

70-1430-108 • ea.

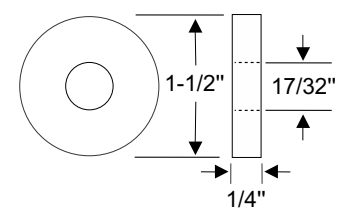

70-0264-108 • ea.

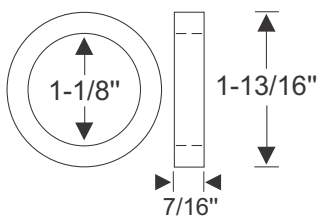

27-0104-108 • ea.

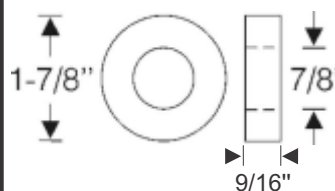

60-0189-108 • ea.

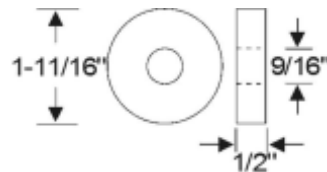

40-0230-108 • ea.

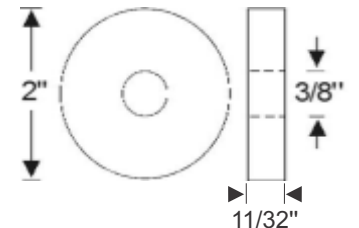

50-0133-108 • ea.

BODY MOUNTING PADS

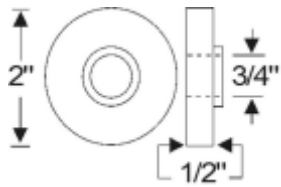

50-0478-108 • ea.

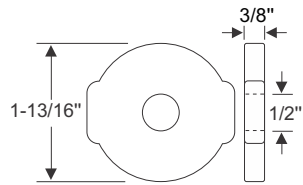

40-0233-108 • ea.

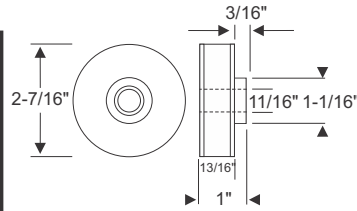

70-2603-108 • ea.

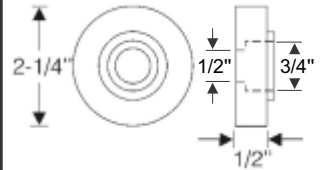

70-1429-108 • ea.

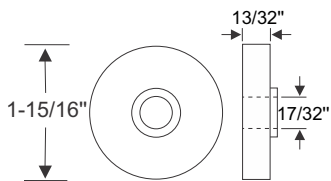

40-0231-108 • ea.

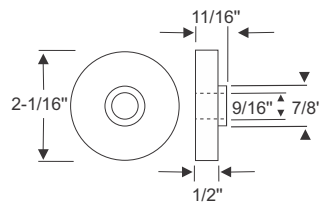

40-0234-108 • ea.

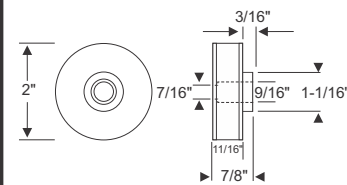

70-2605-108 • ea.

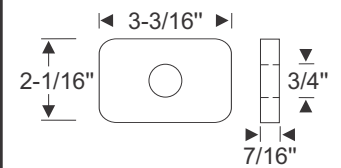

70-0634-108 • ea.

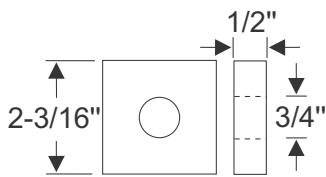

70-2234-108 • ea.

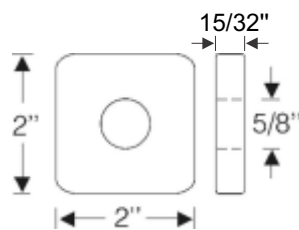

50-0328-108 • ea.

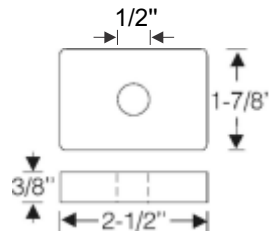

50-0233-108 • ea.

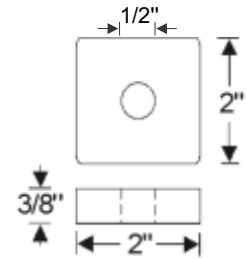

50-0232-108 • ea.

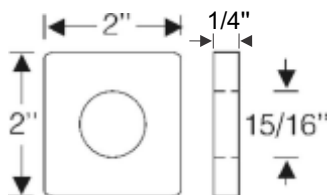

50-0361-108 • ea.

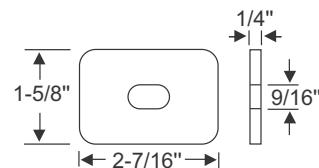

60-0027-108 • ea.

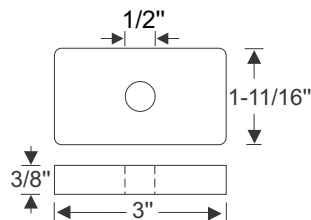

50-0231-108 • ea.

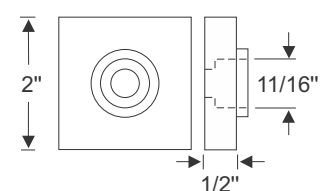

50-0096-108 • ea.

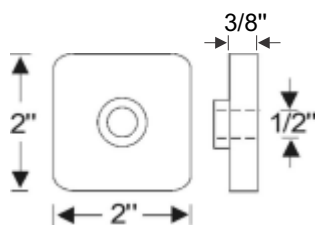

50-0131-108 • ea.

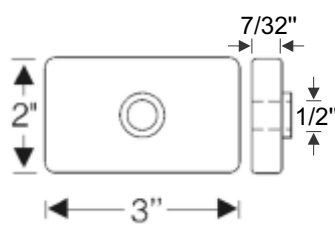

70-0235-108 • ea.

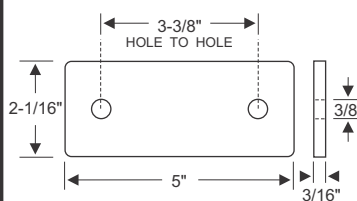

20-0500-108 • ea.

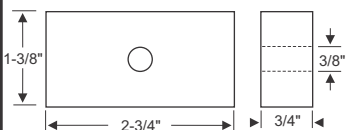

20-3026-108 • ea.

FENDER WELTING

Enjoy a squeak free ride in your Street Rod or Custom Build by installing fender welting. This fender welting is installed between two (2) flanged metal surfaces, such as the front/rear fenders and the body. These weltings feature reinforced black vinyl over a vinyl core. Need assistance finding the right part for the job? Call 800-650-6190

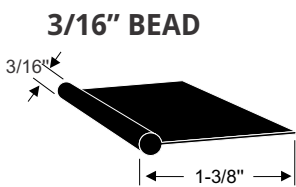

70-1099-119 • 25ft.
70-1100-119 • 50ft.

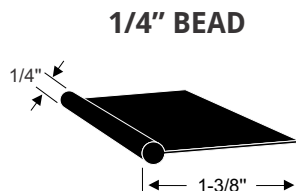

70-1097-119 • 25ft.
70-1098-119 • 50ft.

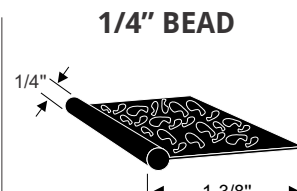

20-1590-119 • 30ft.

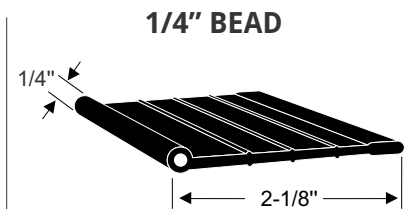

20-1591-119 • 8ft.

FENDER SKIRT / FENDER FLARE / SPASH APRON

FENDER SKIRT

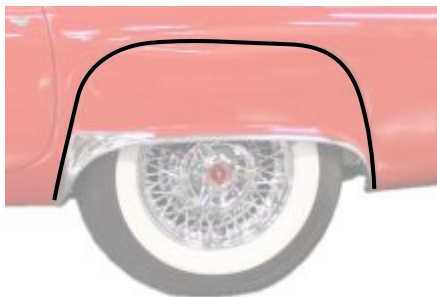

TWO 60" STRIPS

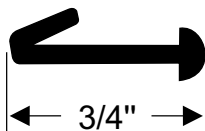

60-0201-119 • pr.

TWO 48" STRIPS



20-0069-119 • pr.

FENDER FLARE



PEEL-N-STICK

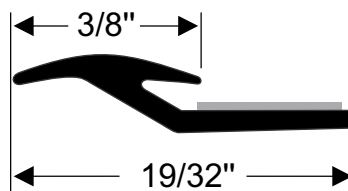

70-4080-120 • per/ft.

CREATE CUSTOM SPLASH APRONS



Masticated sheet containing random milled cotton cord reinforcement for front end splash aprons any many other applications on your Street Rod or Custom Build project.

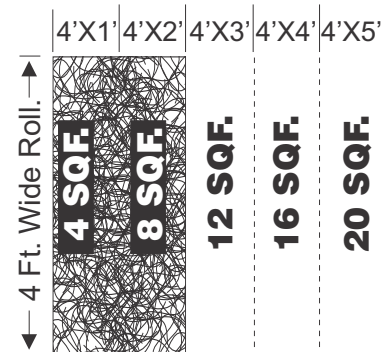

Please order Masticated Sheeting by the square foot as shown.

70-0645-107 • per/sqft.



UNIVERSAL EDGING & MOUNTING GASKETS

Street Rod or Custom Builds require custom solutions for body and fender mounting applications. Our dense rubber extrusions offer an answer for your headlight bezel to fender, taillight to body, windshield frame mounting to cowl, and body to frame use. Need assistance finding the right part for the job? Call 800-650-6190



UNIVERSAL EDGING

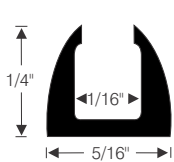

50-0100-119
per/ft.

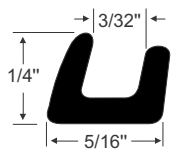

27-0090-119
per/ft.

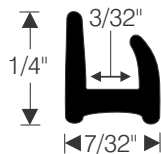

60-0685-119
per/ft.

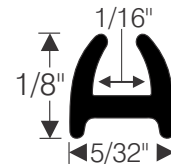

70-0836-119
per/ft.

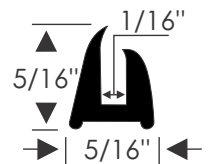

70-2856-119
per/ft.

UNIVERSAL MOUNTING GASKETS

The 2 extrusions listed below are perfect for creating your own custom gaskets. Just notch the flat part of the rubber as shown and bend to follow the shape you need.

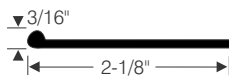

70-0019-119 • per/ft.

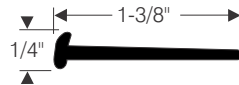

70-0308-119 • per/ft.



NOTCH THE FLAT PART OF RUBBER WITH SHARP SCISSORS



RUBBER EXTRUSION WILL LOOK SIMILAR TO THIS



NOW YOU CAN FORM
EXTRUSION TO ANY
CUSTOM SHAPE AND
CREATE CUSTOM GASKETS



**CREATE
CUSTOM
GASKETS**



BRAKE & CLUTCH PEDALS

There are few things in a Street Rod or Custom Build that you interact with as much as the brake and clutch pedals, that's why keeping them up to date will enhance your ride experience. We offer generic and OEM badged brake and clutch pedal pads. Need assistance finding the right part for the job? Call 800-650-6190

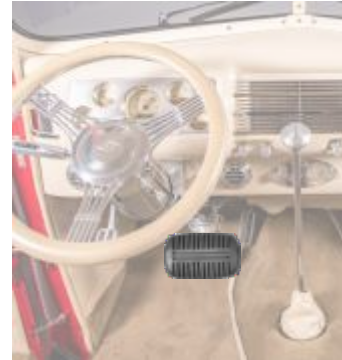

ALL PEDALS ARE BLACK RUBBER UNLESS OTHERWISE NOTED

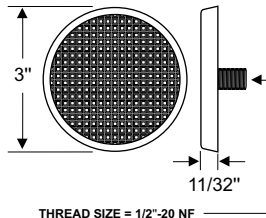

20-0325-108 • pr.

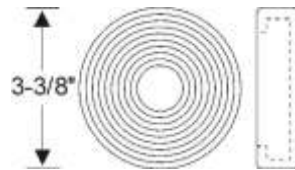

12-0013-108 • pr.

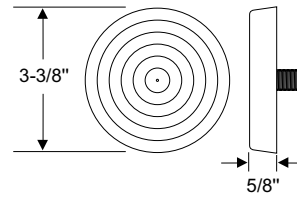

20-1563-108 • pr.

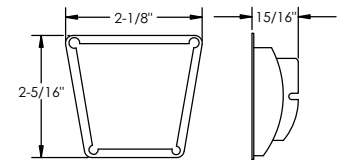

70-2711-108 • ea.

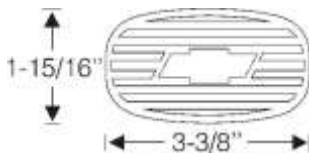

60-0125-108 • pr.

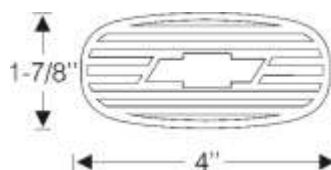

60-0043-108 • pr.

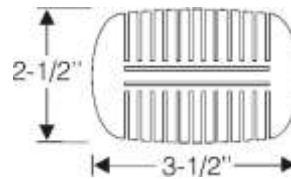

60-0242-108 • pr.

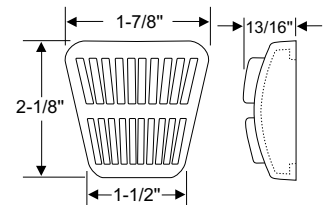

20-0755-108 • ea.

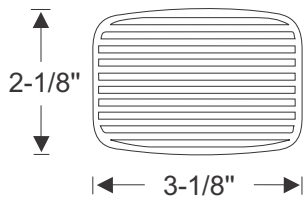

50-0054-108 • pr.

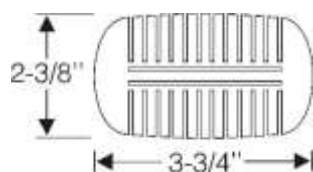

60-0218-108 • pr.

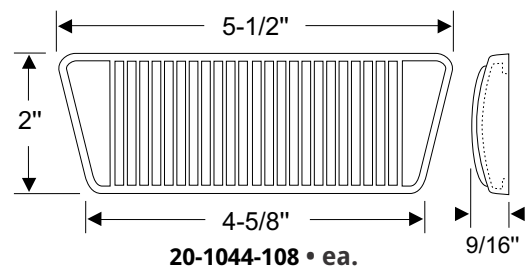

20-1044-108 • ea.

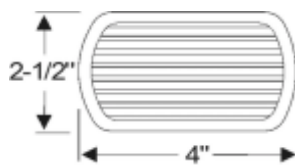

25-0058-108 • pr.

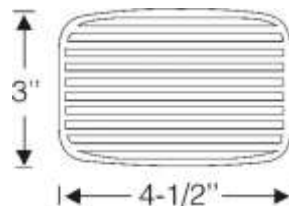

50-0285-108 • ea.

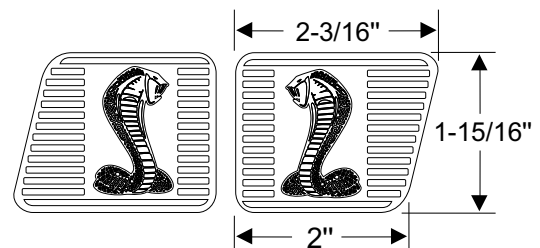

70-4201-108 • pr.

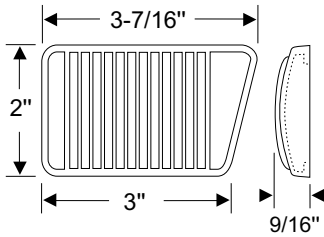

20-1043-108 • ea.

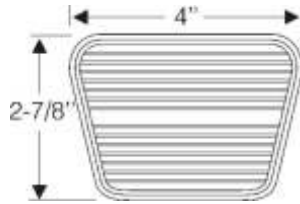

60-0712-108 • ea.

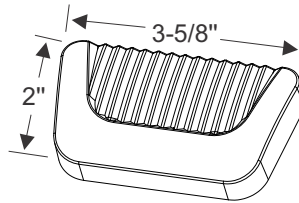

40-0287-108 • ea.

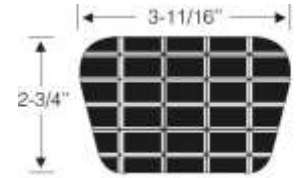

60-0467-108 • ea.

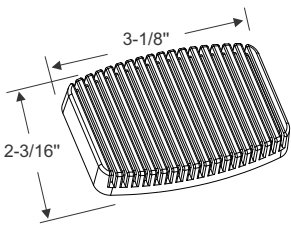

LIGHT BROWN RUBBER
25-0024-108 • pr.

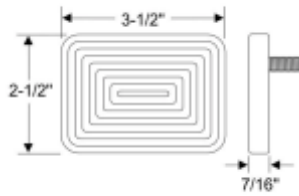

20-2452-108 • pr.

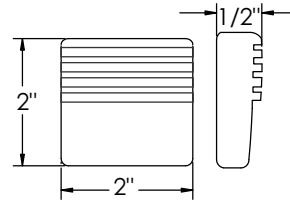

70-3003-108 • pr.

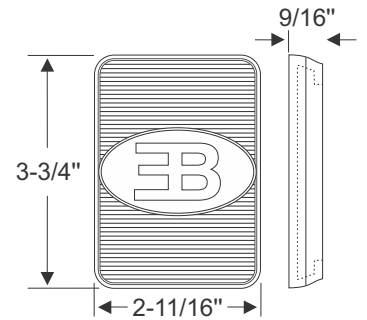

10-0176-108 • pr.

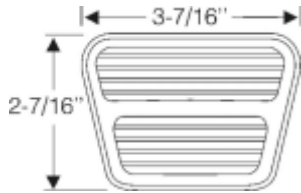

60-0709-108 • ea.

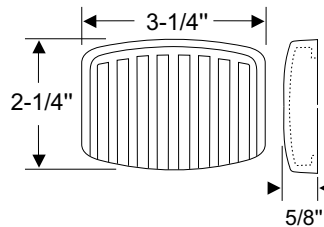

20-1820-108 • ea.

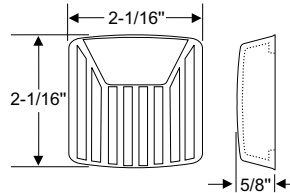

20-0016-108 • ea.

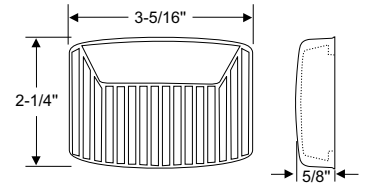

20-0848-108 • ea.

BRAKE & CLUTCH BOOTS

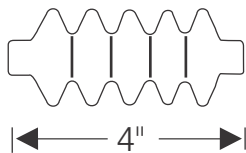

60-0067-108 • pr.

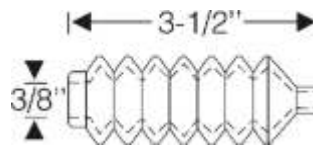

60-0155-108 • pr.

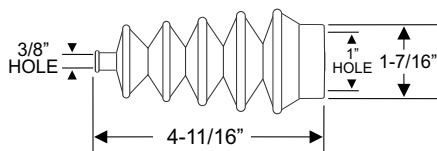

20-0249-108 • ea.

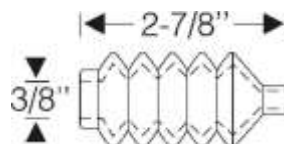

60-0156-108 • pr.

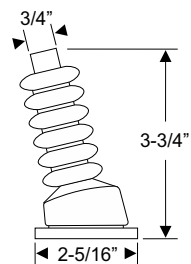

20-1049-108 • ea.

ACCELERATOR PEDALS

Designed for your creative application and use, Accelerator Pedal Pads give your Street Rod or Custom Build project the finishing touch you have been looking for. Need assistance finding the right part for the job? Call 800-650-6190

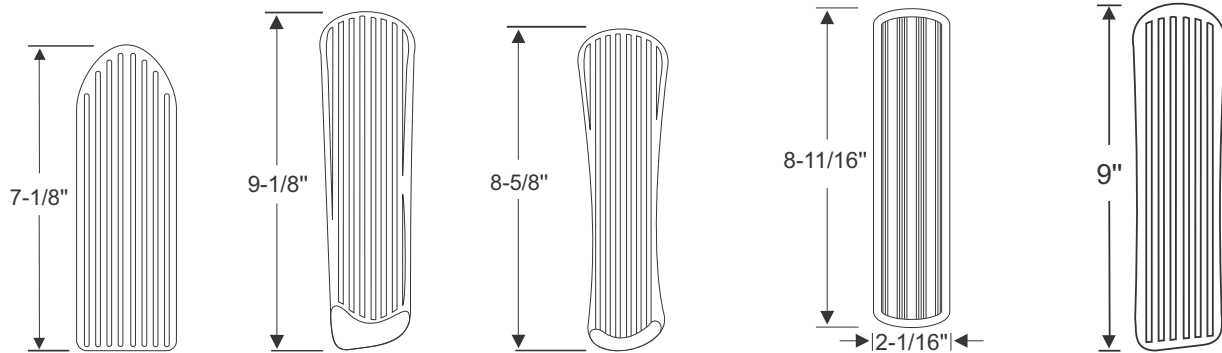
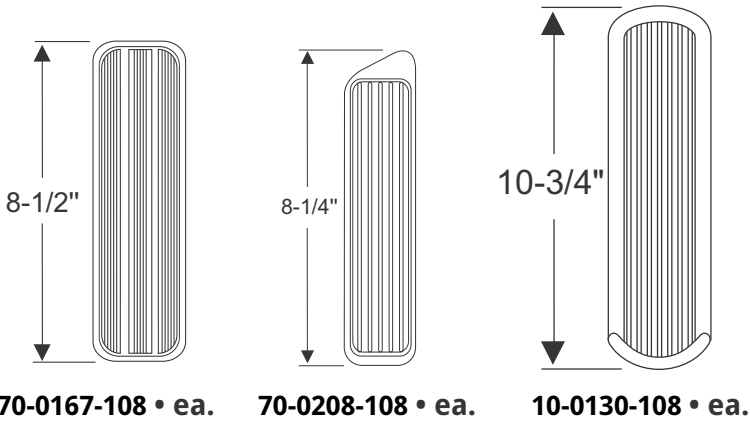

60-0085-108 • ea. 50-0038-108 • ea. 50-0037-108 • ea. 40-0113-108 • ea. 50-0160-108 • ea.

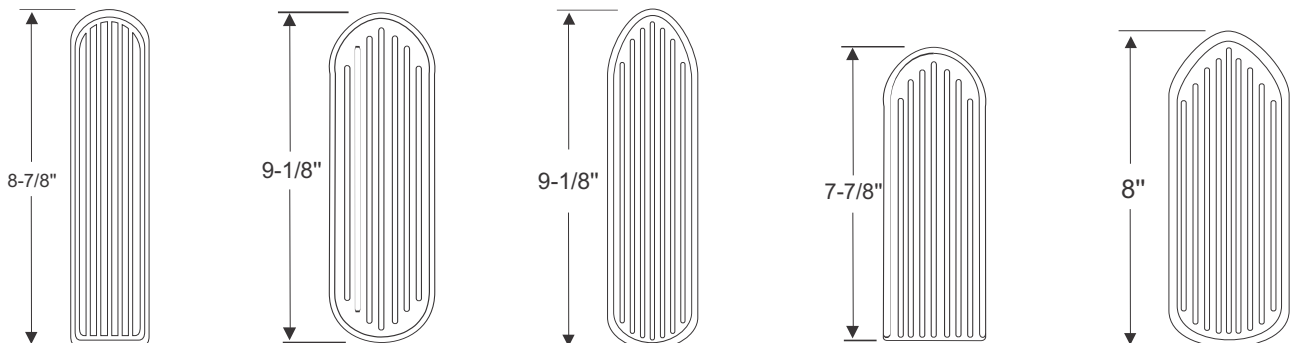

60-0239-108 • ea. 60-0448-108 • ea. 60-0097-108 • ea. 60-0430-108 • ea. 60-0301-108 • ea.

FUEL FILLER GROMMETS

Fuel Filler Neck Grommets are fully molded from dense EPDM rubber and offer versatility for your Street Rod or Custom Build project. Need assistance finding the right part for the job? Call 800-650-6190

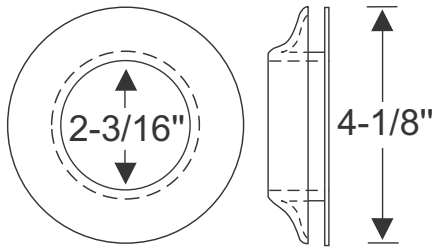

70-0050-108 • ea.

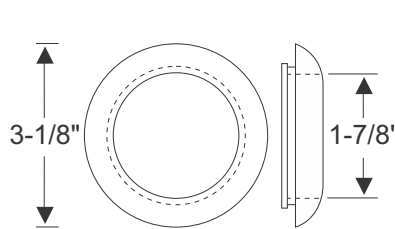

70-2203-108 • ea.

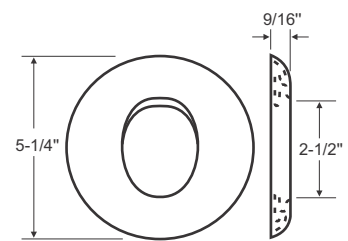

70-1848-108 • ea.

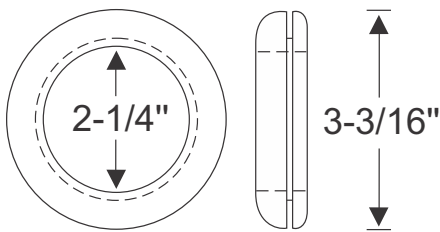

50-0245-108 • ea.

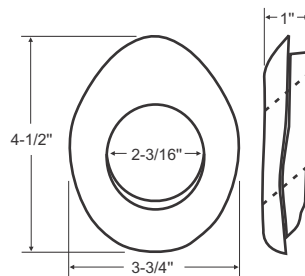

20-0345-108 • ea.

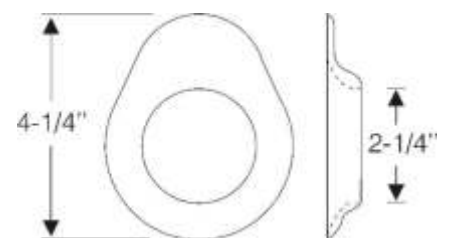

60-0405-108 • ea.

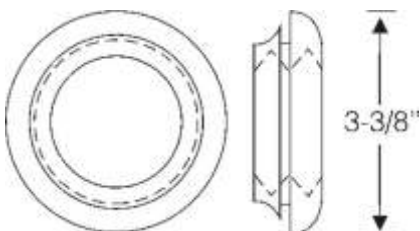

70-1439-108 • ea.

**ASK ABOUT
OUR VEHICLE
SPECIFIC FUEL
FILLER GROMMETS**

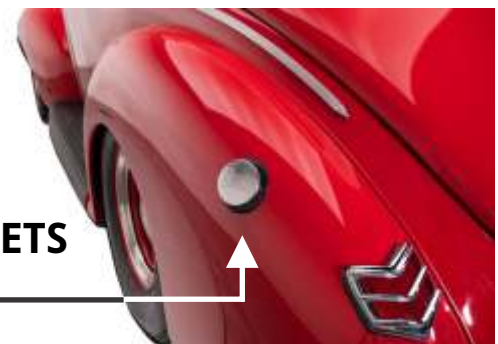

FUEL DOOR BUMPERS

Our Fuel Door Bumpers are made from dense EPDM rubber offering superior strength and versatility. Designed for the builder's creative application and use, these can also be used as license plate bumpers & door bumpers. Need assistance finding the right part for the job? Call 800-650-6190

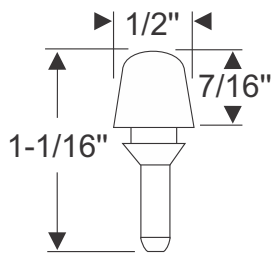

30-0368-108 • ea.

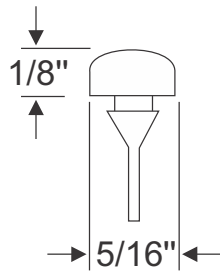

33-0127-108 • ea.

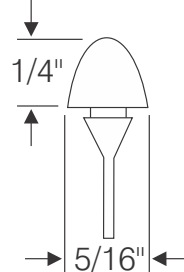

33-0128-108 • ea.

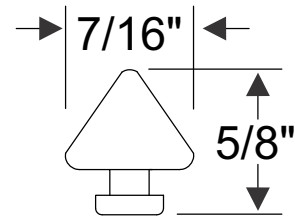

70-2736-108 • ea.

FUEL TANK MOUNTING STRAPS

Fuel Tank Support Pads and Mounting Strap Cushions are a great addition to any Street Rod or Custom Build. These anti-squeak straps create a cushion for batteries, fuel, and air tank mountings. Designed to be used as a base behind metal or plastic straps.

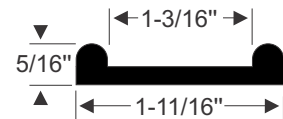

30-0482-119 • per/ft.

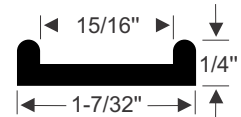

70-3612-119 • per/ft.



SINCE 1958





GEARSHIFT BOOTS

There's more to brake and clutch components than just the pedals. Enhance the look and feel of your Street Rod or Custom Build with these shifter boots, floorplates, knobs, and bushings. Need assistance finding the right part for the job? Call 800-650-6190

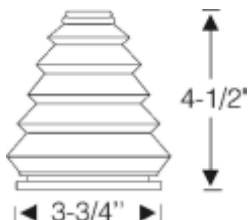

70-0228-108 • ea.

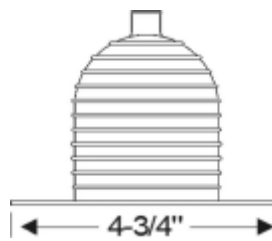

40-0076-108 • ea.

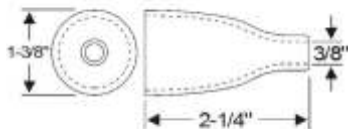

30-0069-108 • ea.

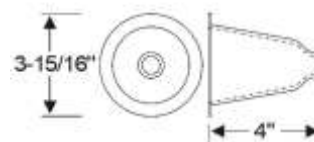

40-0111-108 • ea.

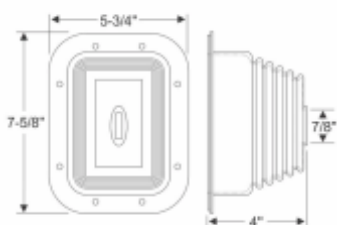

82-0222-108 • ea.

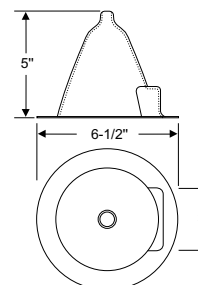

BROWN RUBBER
20-2166-108 • ea.

GEARSHIFT FLOORPLATES

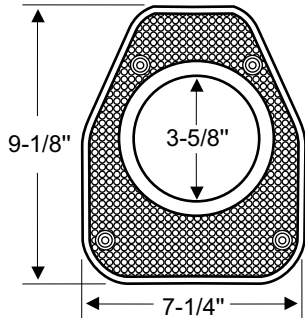

18-0001-108 • ea.

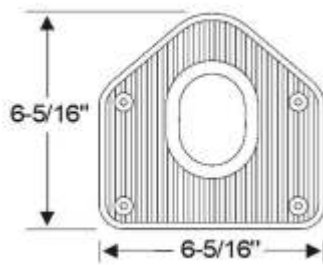

40-0105-108 • ea.

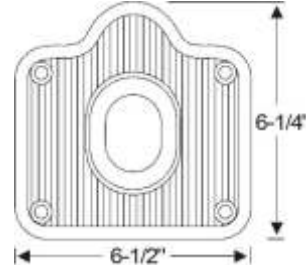

40-0327-108 • ea.

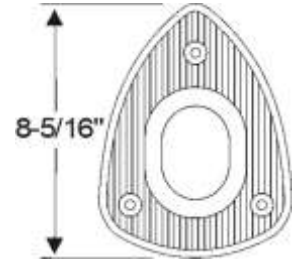

40-0108-108 • ea.

HANDBRAKE FLOORPLATES

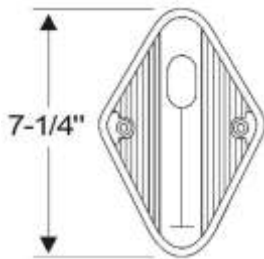

40-0109-108 • ea.

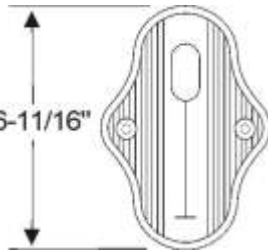

40-0110-108 • ea.

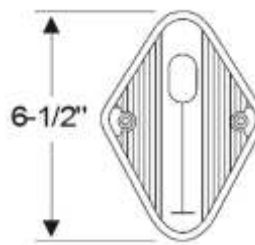

40-0106-108 • ea.

HANDBRAKE GRIPS

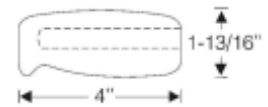

70-0385-108 • ea.

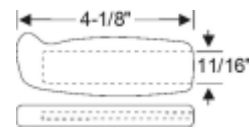

30-0322-108 • ea.

GEARSHIFT KNOBS



30-0153-108 • ea.



30-0349-108 • ea.

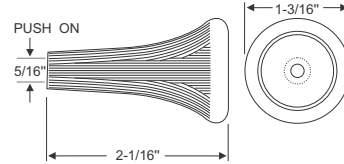

20-0763-108 • ea.

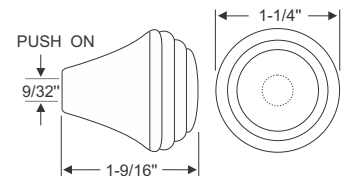

20-0332-108 • ea. (BLACK)
20-0331-108 • ea. (CREAM)

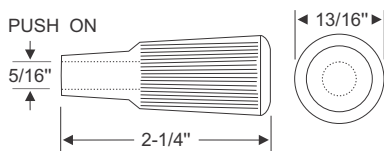

20-0630-108 • ea.

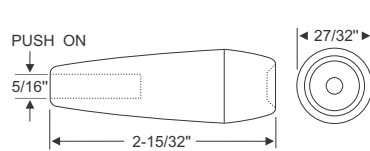

20-0521-108 • ea. (BLACK)
20-0629-108 • ea. (CREAM)

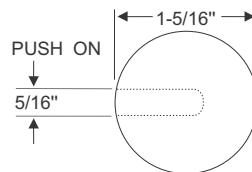

20-0461-108 • ea.

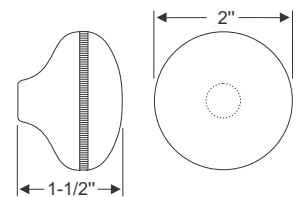

SCREWS ON 3/8-24 THREAD
20-0583-108 • ea.

ROUND GROMMETS

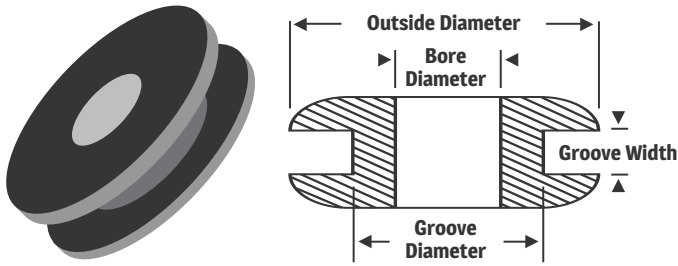

GROOVE DIAMETER = PROJECT HOLE SIZE

Part Number	GROOVE DIAMETER	Bore Diameter	Outside Diameter	Groove Width
32-1059-20	1/4"	5/32"	3/8"	1/16"
32-1060-20	1/4"	5/32"	7/16"	3/32"
32-1062-20	9/32"	5/32"	13/32"	3/32"
32-1063-20	5/16"	5/32"	7/16"	1/4"
32-1061-20	5/16"	3/16"	1/2"	1/16"
32-0352-20	3/8"	1/4"	9/16"	1/16"
32-0414-32	3/8"	5/32"	9/16"	5/32"
32-1064-20	3/8"	1/4"	1/2"	1/16"
32-1058-20	3/8"	1/8"	1/2"	3/32"
32-0514-20	3/8"	1/4"	5/8"	1/16"
32-0317-52	7/16"	1/4"	3/4"	1/16"
32-0366-53	7/16"	1/8"	5/8"	1/16"
32-1065-20	7/16"	1/4"	5/8"	1/16"
32-0537-24	7/16"	1/4"	3/4"	1/16"
32-1067-20	7/16"	5/16"	9/16"	1/16"
32-0365-20	1/2"	3/16"	3/4"	1/16"
32-0161-21	1/2"	3/8"	11/16"	1/16"
32-0132-67	1/2"	3/8"	13/16"	3/32"
32-1073-20	9/16"	7/16"	3/4"	1/16"
32-1070-20	9/16"	5/16"	13/16"	1/4"
32-0051-24	9/16"	3/8"	5/8"	5/32"
32-0491-21	9/16"	3/8"	15/16"	5/32"
32-1069-20	9/16"	5/16"	3/4"	1/8"
32-0158-17	9/16"	5/16"	13/16"	1/16"
32-1071-20	5/8"	3/8"	7/8"	1/16"
32-1072-20	5/8"	3/8"	7/8"	1/4"
32-0970-17	5/8"	7/32"	13/16"	3/32"
32-0112-20	11/16"	1/4"	1-3/16"	1/16"
32-0047-14	11/16"	3/8"	1"	1/16"
32-0165-15	11/16"	1/8"	15/16"	1/16"
32-0050-24	11/16"	15/32"	3/4"	1/4"
32-0003-21	11/16"	5/16"	1"	1/16"
32-0328-54	11/16"	3/8"	1-3/16"	1/16"
32-1068-20	3/4"	5/16"	1"	1/16"
32-0342-24	3/4"	3/8"	1"	3/16"
32-1075-20	3/4"	1/2"	1"	1/8"
32-0438-20	3/4"	1/2"	1"	3/32"
32-1074-20	3/4"	1/2"	31/32"	3/32"

Part Number	GROOVE DIAMETER	Bore Diameter	Outside Diameter	Groove Width
32-0263-17	3/4"	5/16"	1"	1/16"
32-0066-20	3/4"	1/4"	15/16"	1/16"
32-0162-21	3/4"	1/4"	15/16"	1/16"
32-0064-21	13/16"	1/4"	1"	1/16"
32-1076-20	13/16"	1/2"	1-1/16"	1/4"
32-0002-21	7/8"	13/32"	1-1/16"	1/16"
32-0224-21	7/8"	5/8"	1-1/8"	1/16"
32-1077-20	7/8"	5/8"	1-1/8"	1/8"
32-0057-24	7/8"	5/16"	1-1/4"	1/8"
32-0155-37	7/8"	1/2"	1-5/16"	1/16"
32-0364-37	29/32"	5/8"	1-1/4"	3/32"
32-1078-20	15/16"	3/4"	1-1/8"	1/16"
32-0039-14	15/16"	1/4"	1-1/4"	1/16"
32-0133-21	31/32"	3/4"	1-3/16"	3/16"
32-1066-20	31/32"	1/4"	1-7/32"	1/16"
32-0464-15	1"	3/8"	1-3/8"	1/16"
32-0714-41	1"	3/8"	1-5/16"	1/16"
32-0492-14	1"	11/16"	1-1/4"	1/16"
32-0320-21	1"	7/16"	1-7/16"	1/16"
32-0439-20	1"	7/16"	1-5/16"	1/16"
32-0390-21	1"	3/4"	1-1/4"	1/16"
32-0098-21	1"	1/4"	1-5/16"	1/16"
32-0401-45	1"	3/8"	1-1/4"	1/16"
32-0437-20	1-1/16"	7/16"	1-3/8"	1/16"
32-0253-37	1-1/16"	5/8"	2-1/16"	3/32"
32-0369-20	1-1/16"	3/4"	1-3/8"	1/16"
32-0134-20	1-1/16"	13/16"	1-5/16"	5/32"
32-1201-20	1-3/32"	9/16"	1-9/16"	3/32"
32-0167-52	1-3/32"	7/8"	1-7/16"	1/16"
32-0005-14	1-1/8"	5/8"	1-3/8"	1/16"
32-0001-37	1-1/8"	3/4"	1-9/16"	1/16"
32-0365-37	1-5/32"	5/8"	1-9/16"	3/32"
32-0062-14	1-5/32"	3/4"	1-7/16"	1/16"
32-0355-37	1-1/4"	5/8"	2"	1/16"
32-1079-20	1-1/4"	3/4"	1-5/8"	1/4"
32-0421-37	1-1/4"	3/4"	1-9/16"	1/4"
32-0422-20	1-1/4"	1/2"	1-7/16"	1/4"
32-0220-21	1-1/4"	1/4"	1-1/2"	1/16"
32-0118-37	1-1/4"	3/4"	1-5/8"	1/16"
32-0063-14	1-5/16"	1/2"	1-5/8"	1/16"
32-0455-14	1-5/16"	7/8"	1-5/8"	1/16"
32-0023-14	1-5/16"	1-1/16"	1-7/8"	1/16"
32-0196-21	1-5/16"	5/16"	1-11/16"	1/16"
32-0160-20	1-3/8"	1/2"	1-11/16"	1/8"
32-0062-20	1-3/8"	5/16"	1-7/8"	1/8"
32-0333-20	1-3/8"	7/16"	1-3/4"	3/32"
32-0225-20	1-1/2"	11/16"	2-1/4"	3/32"

STEM BUMPERS

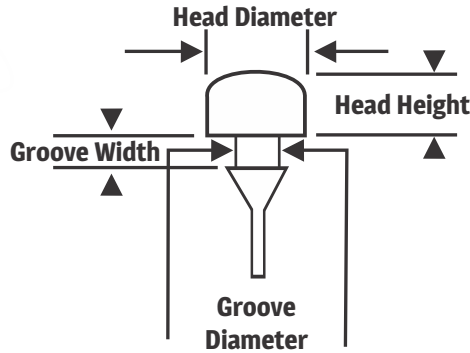
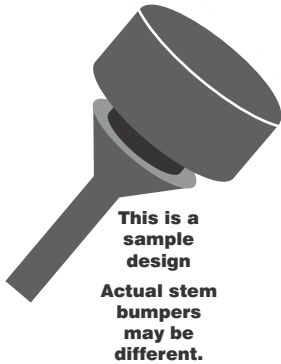

GROOVE DIAMETER = PROJECT HOLE SIZE

Our stem bumpers can be used to protect a variety of applications. Bumpers are listed below by the size of the Groove Diameter (which is the project hole size). Please call if you need assistance.

Call or visit our website for current pricing

Part Number	GROOVE DIAMETER	Head Diameter	Head Height	Groove Width
33-0730-42	1/8"	3/8"	3/32"	1/8"
33-0127-108	1/8"	5/16"	1/8"	1/16"
33-0128-108	1/8"	5/16"	1/4"	1/16"
33-0556-15	1/8"	1/2"	1/16"	7/32"
33-0348-54	3/16"	1/2"	5/8"	1/16"
33-0368-108	3/16"	1/2"	7/16"	1/8"
33-0507-62	3/16"	7/16"	1/8"	5/32"
33-0990-87	3/16"	15/16"	1/2"	1/16"
33-0117-42	3/16"	5/8"	5/16"	1/16"
33-0349-87	3/16"	1/2"	3/32"	1/16"
33-0042-42	3/16"	7/16"	1/2"	1/16"
33-0123-42	1/4"	3/4"	1/2"	1/16"
33-0512-44	1/4"	3/8"	5/32"	1/16"
33-0136-42	1/4"	1/2"	5/16"	1/16"
33-0211-31	1/4"	5/8"	1/4"	1/16"
33-0293-87	1/4"	7/8"	5/16"	1/16"
33-0459-42	1/4"	3/4"	3/16"	1/16"
33-0496-71	1/4"	1/2"	3/8"	1/16"
33-1285-42	1/4"	9/16"	3/16"	1/16"
33-0395-42	1/4"	9/16"	3/32"	1/16"

Part Number	GROOVE DIAMETER	Head Diameter	Head Height	Groove Width
33-0350-87	1/4"	15/16"	3/8"	1/16"
33-0427-42	1/4"	5/8"	3/16"	1/16"
33-0482-42	1/4"	5/8"	7/16"	1/16"
33-0046-42	1/4"	3/4"	5/16"	1/16"
33-1574-71	1/4"	5/8"	1/4"	1/16"
33-0003-42	1/4"	11/16"	1/8"	3/32"
33-0019-20	1/4"	15/32"	3/16"	1/16"
33-0449-42	1/4"	1/2"	1/4"	1/16"
60-0734-71	1/4"	9/16"	1/4"	1/16"
33-1576-71	5/16"	9/16"	1/2"	1/16"
33-1575-71	5/16"	5/8"	3/4"	1/16"
33-0531-42	5/16"	13/16"	1/4"	1/8"
33-0031-42	5/16"	1/2"	1/8"	1/16"
33-0109-71	5/16"	3/4"	1/4"	3/32"
33-0116-42	5/16"	3/4"	7/16"	3/32"
33-0542-42	5/16"	3/4"	5/16"	1/16"
33-0113-42	5/16"	3/4"	3/16"	1/16"
33-0293-71	5/16"	3/4"	11/16"	1/16"
33-0016-45	3/8"	1"	11/32"	1/16"
33-0169-42	3/8"	11/16"	3/8"	1/16"

Stem bumpers come in a variety of shapes. These are examples of different stem bumpers.





ROUND BODY PLUGS

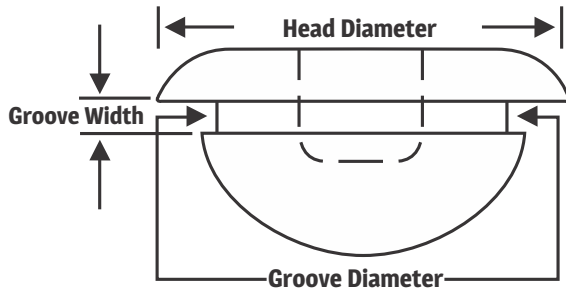

Our body plugs can be used for a variety of applications. Body Plugs are listed by the size of the groove diameter. (which is the project hole size). Please call if you need assistance.

GROOVE DIAMETER = PROJECT HOLE SIZE

Part Number	GROOVE DIAMETER	Head Diameter	Material	Groove Width
35-0458-45	3/8"	5/8"	Rubber	1/8"
35-0369-20	1/2"	3/4"	Rubber	3/32"
35-0070-87	1/2"	3/4"	Rubber	1/16"
35-1052-20	1/2"	7/8"	Plastic	1/16"
35-0171-20	9/16"	13/16"	Rubber	None*
35-0197-31	3/4"	1-1/8"	Rubber	3/32"
35-0262-20	3/4"	1"	Rubber	1/16"
35-0515-20	3/4"	1"	Rubber	1/16"
35-1053-20	3/4"	1-1/8"	Plastic	1/16"
35-1054-20	3/4"	1-1/4"	Plastic	1/16"
35-0402-87	7/8"	1-3/32"	Rubber	1/16"
35-0099-20	15/16"	1-3/16"	Rubber	1/16"
35-1214-20	1"	1-5/16"	Rubber	1/16"
35-0457-45	1"	1-3/8"	Rubber	1/16"
35-1055-20	1"	1-3/8"	Plastic	1/16"
35-0327-45	1-1/8"	1-1/2"	Rubber	1/16"
35-1056-20	1-1/4"	1-5/8"	Plastic	1/16"
35-0517-45	1-3/8"	1-5/8"	Rubber	1/16"
35-3508-45	2"	2-7/16"	Rubber	3/32"

*Part# 35-0171-20 has NO groove

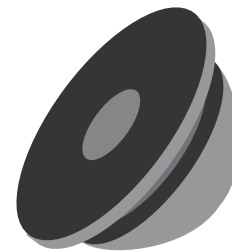

This is a sample design.

Body plugs come in a variety of sizes. These are examples of our body plugs.



Part# 32-0456-20



Part# 35-0369-20



Part# 35-1214-20

Call or visit our website for current pricing

3M Masking Tape



3M™ Automotive Performance Masking Tape is a quality masking tape developed for the special requirements of the automotive restoration industry. It provides excellent adhesion to moldings, metal, plastic and rubber.

96-3433-96 - 1/2" WIDE

96-3431-96 - 3/3" WIDE

3M Super Strength Molding Tape



3M Super Strength Molding Tape is ideal for permanently attaching side moldings and trim to your vehicles, adding long-term protection and value. This tape features an extremely strong adhesive that's also easy to use. Just pull of the red liner and apply. 2 widths available.

96-3616-96 - 7/8" WIDE TAPE

96-3614-96 - 1/2" WIDE TAPE

3M Adhesion Promoter Sponge Applicator Packet



Formulated specifically for use with 3M Super Strength Molding Tapes, promotes a permanent bond with most low surface energy plastic materials commonly used in interior trim and exterior trim parts.

96-6396-96

3M Super Weatherstrip Adhesive Black (2 oz.)*



Designed specifically to bond rubber gaskets and weatherstripping to metal surfaces. This flexible, high-strength adhesive helps ensure a tight waterproof seal on car doors, trunks, roof rails and more. Black or Yellow. 2 oz. tube.

96-8581-96 - BLACK

96-8002-96 - YELLOW

*State of California Only WARNING:

Products with an asterisk (*) can expose you to chemicals including toluene which is known to the State of California to cause cancer or birth defects or other reproductive harm.

For more information, visit www.P65Warnings.ca.gov

3M Super Weatherstrip Adhesive Black or Yellow (5 oz.)*



This Super Weatherstrip Adhesive is designed to bond seals and gaskets to metal to ensure a waterproof and airtight seal inside your vehicle. This adhesive is ideal for weatherstripping around doors, trunk, t-tops, sunroofs, and windows. This adhesive creates a

permanent bond when used on rubber, fabrics, seals, and metal. Although the adhesive remains pliable it is still resistant to the elements, detergents, grease, and more. Choice of black or yellow adhesive. 5 oz. tube.

96-8008-96 (BLACK)

96-8001-96 (YELLOW)

3M Weatherstrip Adhesive Black (5 oz.)*



This Black Weatherstrip Adhesive is designed to bond weatherstrip and seals to other rubber parts and specifically to EPDM rubber. This adhesive is ideal for door, trunk, t-top, and sunroof weatherstripping.

This adhesive creates a permanent bond when used on rubber, fabrics, vinyl, and metal. Although the adhesive remains pliable it is still resistant to the elements, oil, grease, and solvents. 5 oz. tube.

96-8011-96

Loctite Super Bonder 495



General purpose instant adhesive designed to bond rubber, metal and plastic parts. Excellent for modified gaskets or rubber footage made of dense or sponge rubber. 3 gm. tube.

96-0495-96

Call or visit our website for current pricing



Black Windshield and Body Sealant



A flexible Windshield and Body Sealant designed specifically for creating a watertight seal between windshield rubber gaskets and Street Rod bodies.

96-8509-96

3M Plastic and Emblem Adhesive



An excellent clear adhesive for plastic repair and emblem application. Use this strong, quick-drying adhesive for plastic or metal emblems, interior rigid plastic, tail light lenses, vinyl side moldings or upholstery. 5 oz. tube.

96-8061-96

3M Adhesive Remover - Low VOC



3M Adhesive Remover - Low VOC is ideal for helping dissolve and remove dirt, grease, tar, and many non-curing type adhesives. Cleans without streaking and has proven to be excellent for surface preparation in adhesive applications. While this multipurpose cleaner is suitable for industrial use, it's also safe enough for everyday projects.

96-3618-96

3M Rubberized Undercoating*



3M™ Professional Grade Rubberized Undercoating produces a textured finish which resists chipping, abrasion, exterior rusting and weathering. This coating provides one-coat build-up with no dripping, running or sagging. The undercoating is excellent for automotive undercarriages and for other uses including protection for wheel wells, fenders, quarter panels and more.

96-3584-96

*State of California Only WARNING:

Products with an asterisk (*) can expose you to chemicals including toluene which is known to the State of California to cause cancer or birth defects or other reproductive harm. For more information, visit www.P65Warnings.ca.gov

3M Urethane Adhesive*



3M™ Auto Glass Urethane Windshield Adhesive is a medium viscosity, one-part, moisture-curing urethane adhesive. It is formulated to be fast-curing and non-sagging for rapid results and a clean and simple application process. The features of this adhesive produce a high-strength bond and is ideal for mounting vehicle windshields, backlights, sidelights, and even beltline windowfelts.

96-8693-96

Ferrule installing tool



Installing tool, door and trunk handle ferrule. For 1926-1937 GM cars and trucks using door and trunk handle ferrules such as our #70-0111-69. Without it ferrules are very difficult to install and impossible to reinstall after painting. This tool, copied precisely from a Fisher Body original, does a quick, neat and efficient job of installing ferrules staking them internally to keep them in place. It is precision-machined with a hardened blade, adjusts for depth of reach, knurled for firm grip, and plated for durability. Well worth it for even one car. 6 inches long.

70-0662-69

Scraper/Tuck Tool



This handy tool is great for scraping off old glue and prepping surfaces without damaging metal. Also can be used to help tuck rubber which makes replacing windshield gaskets easier. A good multi purpose tool. Measures: 7-3/4" by 5/8"

94-0110-00

Heavy Duty glass retainer clip tool



This tool is specifically designed to fit trim clips over the studs and virtually eliminates glass breakage. A practical tool for placing trim retainer clips over headed studs welded around the body window shields and rear window openings.

94-0106-94

Panel Clip Retainer Removal Tool



For removing clips and retainers quickly and easily. Simply seat the tool on the shaft of the fastener and squeeze the molded handles together.

94-0100-94

Trim pad and glued in windshield molding removal tool



For auto trim work. Double ended tool combines both left and right hand. Removes reveal molding on rubberless windshield jobs. 9.5 inches long.

94-0108-94

Rope Insertion Tool



This Rope Insertion Tool is specifically designed for use when working with rubber gasket set glass. The grip handle is uniquely injects the rope through its stem as it is pulled around the gasket to install. The tool has enough durable rope to accommodate even the of largest windows.

Eighteen (18) foot rope length provides complete coverage.

94-0118-94

All purpose tool



Use to remove moldings, body clips, windshield seals, cotter pins and radiator hoses. Made of tough spring steel, heat treated, tempered and plated. 8 inches long, 4.875 inch blade with 2 inch hook.

94-0102-94

Ball End Hook Tool



This hook tool has a small, round steel ball on the end. Once the steel ball is inserted down into the rubber gasket, it is very difficult for it to come out. With the ball end design, should the tool indeed slip out of the gasket, there is less of a chance you will scratch the paint of the vehicle.

94-0101-94

Mini Hook Tool Set



This Mini Hook Tool Set offers four (4) different configurations to help you get under and pry up the smallest object.

94-0068-94

Door Panel Clip Tool



This Door Panel Clip Tool provides a quick an easy way to remove door panel clips without causing damage to the trim pad on classic collector vehicles.

94-0017-94

Steele Branded Safety Glasses



Reinforced plastic and wraparound frame.

94-0109-94

Dyna Roller Tool



This Dyna Roller Tool is made of hardwood and serves as an economical tool for applying Ultra-Mat Heat and Sound Insulator Underlayment.

96-1005-96 - 1" ROLLER 96-1007-96 - 2" ROLLER

Locking Strip Tool



The unique design of this Swivel Tip Locking Strip Tool allows the tip to swivel 90 degrees in either direction to work where other tools will not.

94-0111-94

Locking Strip Tool



This tool helps install the 3/8" locking strip used on the windshield and rear window of some cars.

94-0115-94

Rivet Set Tool



Commonly used to secure a rivet which retains weatherstrip installed into a window frame.

94-3740-94

Call or visit our website for current pricing

Vent Window Rivets and Setting Tool



This Vent Window Rivet pair and Setting Tool includes the peening punch and step rivets to replace the hinge post pivot rivet for both left and right vent window assemblies.

70-4789-70

Vent Window Rebuild Set



This Vent Window Rebuild Set includes glass setting tape (1/16"), hinge pivot step rivet pair, and a rivet peening punch. The set has enough materials for both the passenger side and driver side vent window assemblies.

70-4801-70

Vent Window Pivot Post Rivet



Used to replace the hinge post pivot rivet for both left and right vent window assemblies. Sold as each.

70-4757-98

Weatherstrip Installation Kits

Weatherstrip General Installation Kit 90-3355-90



- 1 ea. 3M Weatherstrip Adhesive Black 96-8008-96
- 1 ea. Locktite Super Bonder 495 96-0495-96
- 1 ea. 3M Adhesive Cleaner 96-8987-96
- 1 ea. Scraper/Tuck Tool 94-0110-00
- 1 roll 1-1/2" Masking Tape 96-3431-96
- 3 pr. Nitrile Disposable Gloves
- 2 ea. Adhesive Applicator Sticks
- 1 ea. Steele Rubber Products Decal

Locking Strip Glass Installation Kit 90-3356-90



- 1 ea. Locking Strip Tool 94-0111-94
- 1 ea. Windshield/Body Sealant 96-8509-96
- 1 ea. Ball End Hook Tool 94-0101-94
- 1 ea. Scraper / Tuck Tool 94-0110-00
- 1 roll 1-1/2" Masking Tape 96-3433-96
- 3 pr. Nitrile Disposable Gloves
- 1 ea. Steele Rubber Products Decal

Rope-In Glass Installation Kit 90-3357-90



- 1 ea. Rope Insertion Tool 94-0118-94
- 1 ea. Windshield/Body Sealant 96-8509-96
- 1 ea. Ball End Hook Tool 94-0101-94
- 1 ea. Scraper/Tuck Tool 94-0110-00
- 1 roll 1-1/2" Masking Tape 96-3433-96
- 3 pr. Nitrile Disposable Gloves
- 1 ea. Steele Rubber Products Decal

VEHICLE SPECIFIC CATALOGS ALSO AVAILABLE!



Get your completely customized Steele Rubber Products Catalog!
You tell us what you're working on and we'll send you a catalog
full of parts specifically for that car or truck.
Order as many catalogs as you have projects!



800-650-6190
steelerubber.com/parts

CONTACT US

ONLINE - CHAT
STEELERUBBER.COM

TOLL FREE
800-650-6190

EMAIL
cars@steelerubber.com



Customer Service

Steele provides quality service both before and after your purchase. To place orders, check order status, request a catalog or for any other inquiries, contact us Mon-Friday 8am-6pm Eastern Standard Time at 800-650-6190 (toll free) or 704-483-9343 (local). You can also contact us 24/7 at contact@steelerubber.com.

Return Policy

In the event that you need to return any products, contact us directly Monday-Friday 8am-6pm at 800-461-7089 (toll free) or 704-483-9343 (local) and our Customer Service Representatives will provide you with a return merchandise authorization number (RMA) and instructions for returning any part(s) to us.

Note:

Parts are accepted for return only in the units purchased and with the original invoice. We cannot accept refund packages sent COD or any method for which there is a charge to us. If a part is altered or damaged in any way, we will not be able to accept it for return. We cannot accept returns of products not purchased directly from Steele Rubber Products. Shipping and handling charges are not refundable. To view our full return policy visit: steelerubber.com/returns

Parts Availability

New parts are constantly added to our inventory. Visit us online for current availability of all products.

Delivery of Parts

We cannot guarantee a continuous roll of any extrusion in this catalog when ordered in bulk. We will do our best to ensure that each strip is as long as possible to minimize scrappage for you. Therefore, we reserve the right to deliver your parts in multiple lengths to meet your total purchase requirements.

Use of Parts

These parts are not recommended for specific usage. We are not responsible for damages caused by incorrect installation, abuse, mishandling, accidents or normal wear. Nor will Steele be responsible for labor charges, inconveniences, or any other expenses associated with parts bought through resellers or Steele Rubber Products.

Satisfaction Guarantee:

We offer a 100% satisfaction guarantee on all parts manufactured by and purchased from Steele Rubber Products.

Copyright Section

Contents 2024© Steele Rubber Products, Inc. Printed in the USA. This catalog may not be reproduced without written permission. All drawings, photographs, and graphic images contained in this catalog are the property of Steele Rubber Products and cannot be reproduced without written permission. The contents of this catalog should not be altered in any way for commercial or other use.

Payment Information



For full disclosure of Steele Rubber Products policies please visit us online at <https://www.steelerubber.com>. If you do not have access to the internet and would like a printed version of our policies, please call 800-230-5871 (toll free) or 704-483-9343 (local).

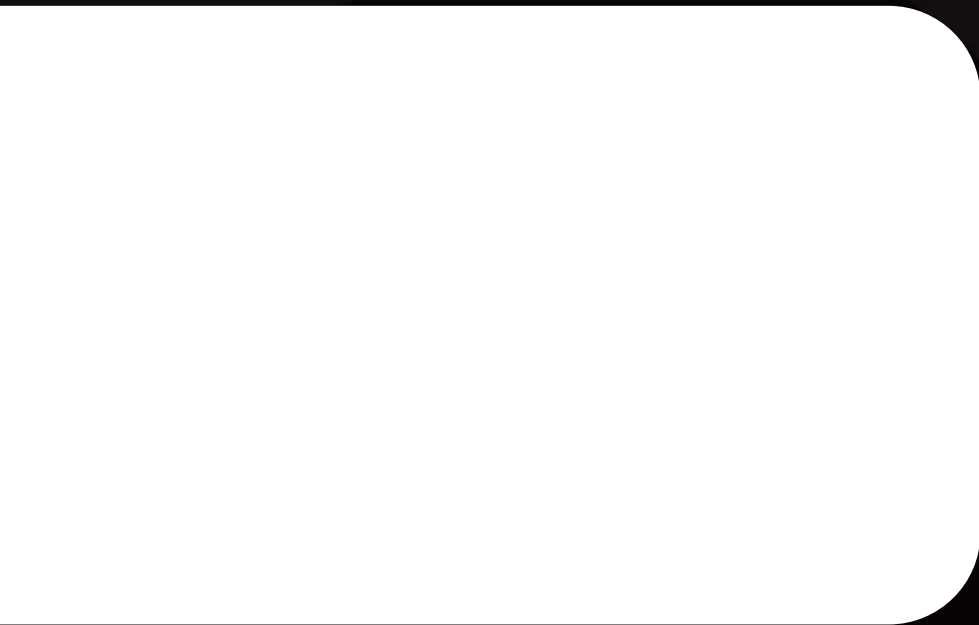

Steele
RUBBER PRODUCTS®



Steele Rubber Products
6180 E. NC 150 HWY
Denver, NC USA 28037

Toll Free 800-650-6190

REVISED
8/29/24