

Steele
RUBBER PRODUCTS®

Universal Parts Catalog

Quality Crafted Rubber Seals and Parts



■ **Dense & Sponge Extrusions**

■ **Rubber Edging**

■ **Trim Seals**

■ **Locking Gaskets**

■ **Grommets**

■ **Bumpers & Plugs**

■ **Rubber Bushings**

■ **Rubber Mounting Pads**

■ **Peel-N-Stick Extrusions**

■ **Adhesives & Cleaners**



THIS IS YOUR UNIVERSAL CATALOG

Thank you for trusting Steele Rubber Products, we've been making quality crafted rubber parts and weatherstripping since 1958. We're a family run business now in its third generation and we continue to proudly manufacture in the United States!

Our goal is to provide you the best quality and fitting seals and weatherstripping available on the market. Learn more about us and everything we offer by visiting our website at steelerubber.com.

HOW TO USE THIS CATALOG

We've done a lot of research to make this catalog easy to use and it's designed to help you find what parts you need. Grouped into specific categories, each part is presented with a profile silhouette and exact dimensions to help you identify the correct shape and size, ensuring the best fit.

We are so determined in finding you the best solution, we even offer samples of our seals before you make the decision to buy. If at any time you need assistance, our team of Product Specialists are here to help.



HOW TO ORDER

GO TO STEELERUBBER.COM

SEARCH FOR
PART NUMBER

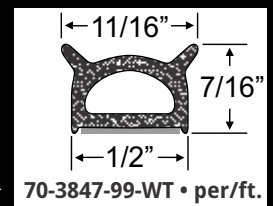

OR CALL

800-230-5871

8am-6pm Eastern

CONTACT US

EMAIL

parts@steelerubber.com

MAIL

6180 E NC 150 HWY
DENVER, NC 28037

Table Of Contents



UNIVERSAL SEALS

DENSE RUBBER SEALS	2
SPONGE RUBBER SEALS	10
EDGING SEALS	14
PEEL-N-STICK SEALS	15
PUSH-ON SEALS	18
GLASS RUN CHANNELS	19
BELTLINE	20

GROMMETS, BUMPERS & PLUGS

GROMMETS	21
BUMPERS	22
PLUGS	23

RV & MARINE

RV WEATHERSTRIPPING	24
MARINE WEATHERSTRIPPING	25

GENERAL USE PARTS

RUBBER SHEETING	26
FENDER WELTING	26
RUBBER BUSHINGS	27
RUBBER PADS	27

ACCESSORIES

ADHESIVES, CLEANERS & SEALERS	28
TOOLS	30

INFORMATION

CUSTOMER SERVICE & PRODUCT ASSISTANCE ..	33
--	----



Since 1958



Steele Rubber Products 6180 E NC 150 HWY Denver NC 28037

steelerubber.com

DENSE RUBBER SEALS

SPONGE RUBBER SEALS ON PAGE 10

Universal Seals

How To Order

All of our universal seals, on pages 2-13, are sold "by the foot". Simply let us know how many feet you require, and we will cut to your custom length.



Possible Uses:

Many of the seals on these pages are perfect for holding glass in a metal track, providing safety and great finishing looks.

<p>70-1192-52</p>	<p>30-0086-99</p>	<p>70-1189-52</p>	<p>30-0512-99</p>	<p>18-0004-77</p>
<p>30-0044-77</p>	<p>70-1297-99</p>	<p>40-0053-99</p>	<p>70-1796-99</p>	<p>60-0687-99</p>
<p>70-0084-99</p>	<p>70-1195-52</p>	<p>70-1190-52</p>	<p>70-3245-99</p>	<p>50-0392-99</p>
<p>30-0478-99</p>	<p>70-1188-52</p>	<p>40-0359-99</p>	<p>70-3286-99</p>	<p>50-0333-99</p>
<p>30-0020-99</p>	<p>70-1191-52</p>	<p>50-0215-99</p>	<p>30-0003-99</p>	<p>60-0083-99</p>
<p>70-1194-52</p>	<p>40-0015-52</p>	<p>70-2092-99</p>	<p>40-0415-99</p>	<p>60-0133-99</p>

Universal Seals



Call or visit our website for current pricing

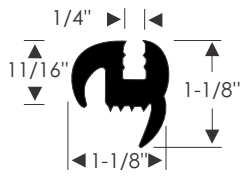

60-0658-99

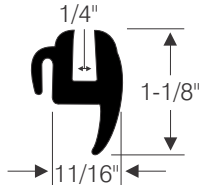

18-0003-83

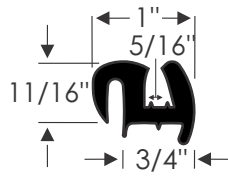

70-1260-99

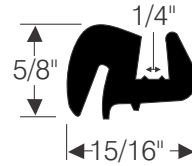

70-0998-99

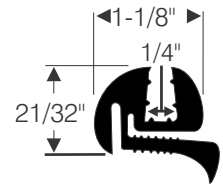

50-0482-99

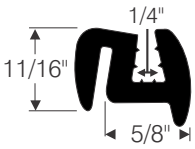

60-0549-99

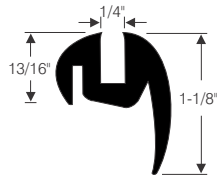

40-0096-99

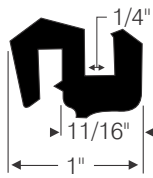

40-0437-99

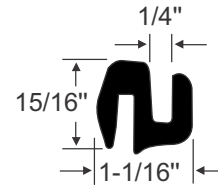

70-1799-99

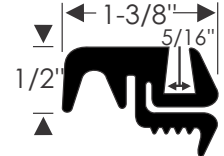

60-0121-99

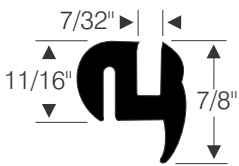

12-0009-99

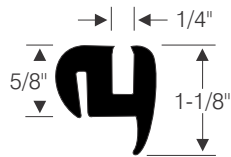

60-0661-99

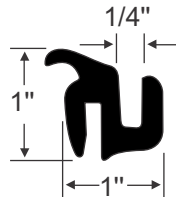

70-1798-99

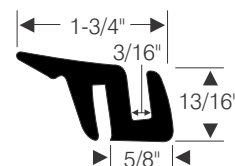

70-3169-99

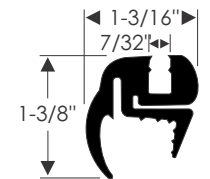

60-0130-99



60-0273-99

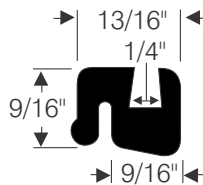

60-0576-99

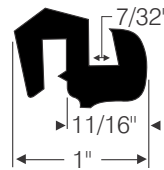

40-0436-99

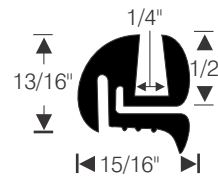

60-0038-99

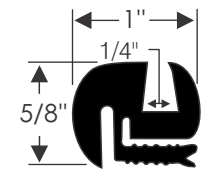

70-2241-99

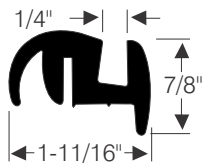

60-0551-99

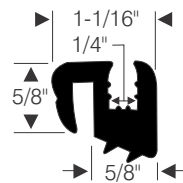

70-3176-99

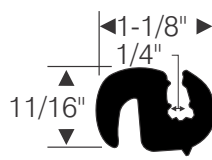

70-1029-99

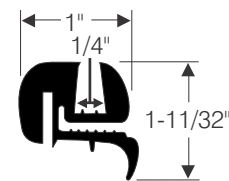

50-0393-99

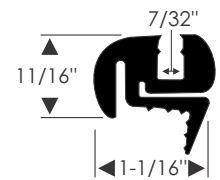

60-0657-99

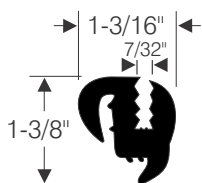

60-0728-99

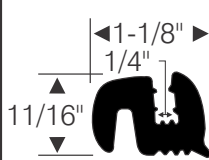

70-1028-99

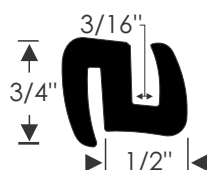

70-3170-99

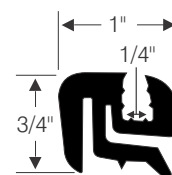

60-0552-99

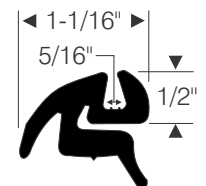

60-0718-99

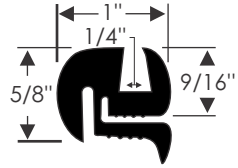

70-2253-99

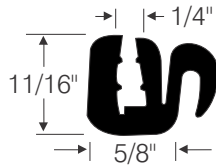

40-0477-99

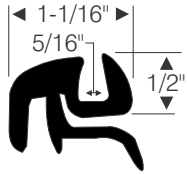

60-0717-99

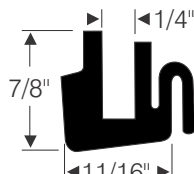

40-0054-99

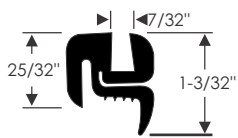

60-0523-99

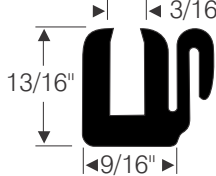

40-0360-99

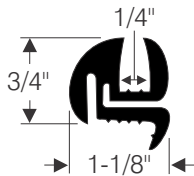

70-1428-99

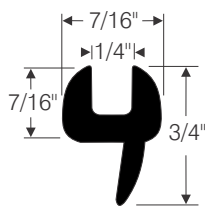

19-0005-99

USES 30-0439-99 LOCKSTRIP
SEE PAGE 5

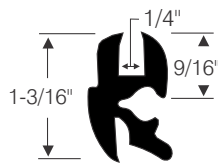

30-0498-99

USES 60-0607-99 LOCKSTRIP
SEE PAGE 5

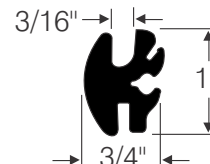

40-0507-99

SELF LOCKING

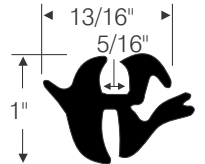

40-0516-99

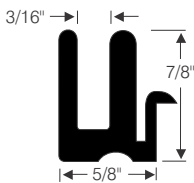

30-0014-99

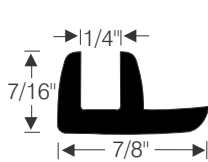

19-0006-99

SELF LOCKING

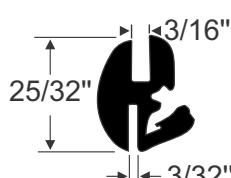

70-4068-457

USES 30-0439-99 LOCKSTRIP
SEE PAGE 5

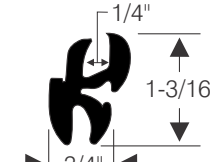

70-1644-99

SELF LOCKING

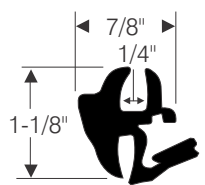

40-0484-99

All of our universal rubber seals on pages 2-13 are sold by the foot. Simply let us know how many feet you require, and we will cut to your custom length.

Call or visit our website for current pricing

USES 30-0439-99 LOCKSTRIP
SEE PAGE 5

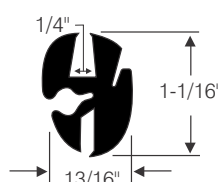

40-0432-99

USES 60-0607-99 LOCKSTRIP
SEE PAGE 5

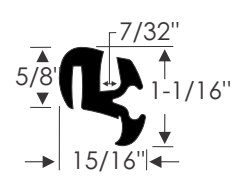

70-1261-99

EXTRUSIONS THAT USE
LOCKING STRIPS*



UNIVERSAL SEAL
THAT ACCEPTS
LOCKING STRIP
(Many on page 4 & 5
use a lock strip)

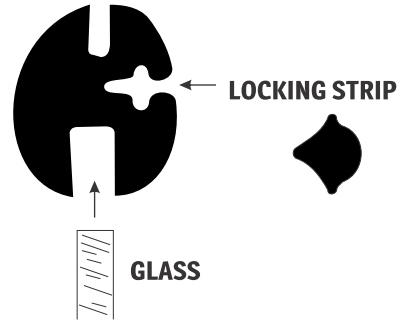

LOCKING STRIPS
LOCKING STRIPS can be used with many of the dense rubber seals on this page. Please see Page 5 for a list of locking strips.

*Typically used on windshield and back window glass on many older cars, trucks and vans.

Universal Seals

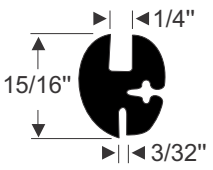
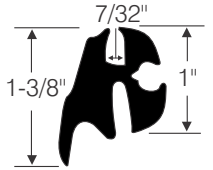
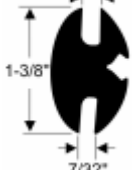
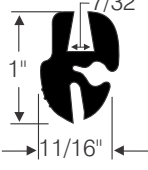
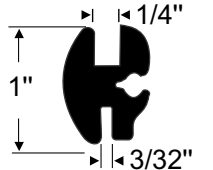
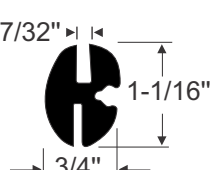
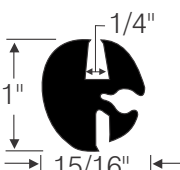
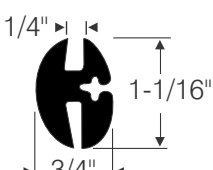
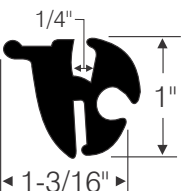
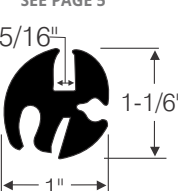
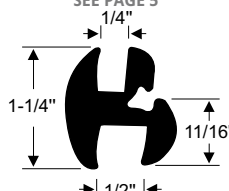
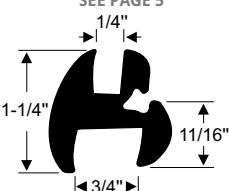

<p>USES 60-0607-99 LOCKSTRIP SEE PAGE 5</p>  <p>60-0082-99</p>	<p>USES 30-0439-99 LOCKSTRIP SEE PAGE 5</p>  <p>40-0519-99</p>	<p>USES 60-0607-99 LOCKSTRIP SEE PAGE 5</p>  <p>70-4299-99</p>	<p>USES 30-0439-99 LOCKSTRIP SEE PAGE 5</p>  <p>30-0436-99</p>
<p>USES 60-0607-99 LOCKSTRIP SEE PAGE 5</p>  <p>40-0548-99</p>	<p>USES 30-0439-99 LOCKSTRIP SEE PAGE 5</p>  <p>40-0496-99</p>	<p>USES 30-0439-99 LOCKSTRIP SEE PAGE 5</p>  <p>40-0433-99</p>	<p>USES 60-0607-99 LOCKSTRIP SEE PAGE 5</p>  <p>70-0587-99</p>
<p>USES 30-0439-99 LOCKSTRIP SEE PAGE 5</p>  <p>40-0520-99</p>	<p>USES 30-0439-99 LOCKSTRIP SEE PAGE 5</p>  <p>40-0511-99</p>	<p>USES 60-0607-99 LOCKSTRIP SEE PAGE 5</p>  <p>70-4774-99</p>	<p>USES 60-0607-99 LOCKSTRIP SEE PAGE 5</p>  <p>70-4775-99</p>

LOCKING STRIPS

 LOCKING STRIPS can be used with many of the dense rubber seals on pages 4 & 5. They lock the gasket in place for a tight weatherproof seal.

UNIVERSAL SEAL THAT ACCEPTS LOCKING STRIP (Pages 4 & 5)

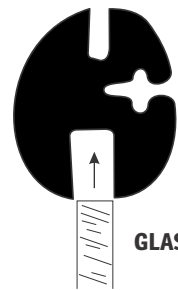

GLASS

Call or visit our website for current pricing

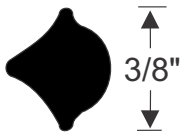

60-0607-99
Sold per/foot

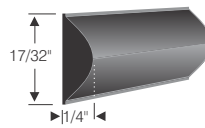

70-1918-52
15ft. Strip

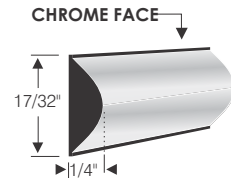

70-1919-52
15ft. Strip

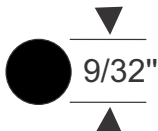

30-0439-99
Sold per/foot

70-2195-52
16ft. Strip

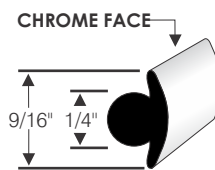

70-2196-52
16ft. Strip

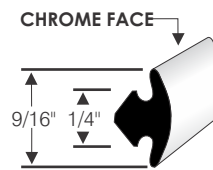

70-3425-52
11ft. Strip

T-RUBBER SEALS

Steele Rubber Product's dense "T-rubber" seals can be used in just about any application where rubber is held in place with a track or channel. Many RV & Marine screen and shower doors utilize T-rubber seals.

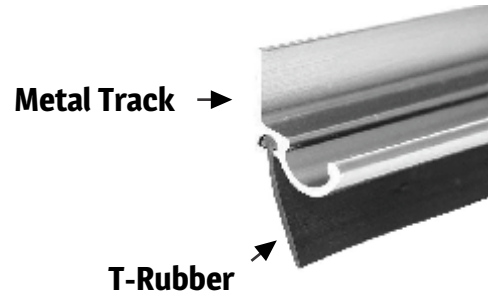

<p>19-0023-73</p>	<p>70-0142-52</p>	<p>70-3788-99</p>	<p>70-1163-52</p>	<p>19-0024-52</p>
<p>70-3898-99</p>	<p>40-0036-99</p>	<p>40-0018-99</p>	<p>40-0033-99</p>	<p>70-0015-99</p>

GLASS SETTING CHANNEL

The "Setting Channel" extrusions listed below are designed to fold in a "U" shape to hold glass away from a metal frame.

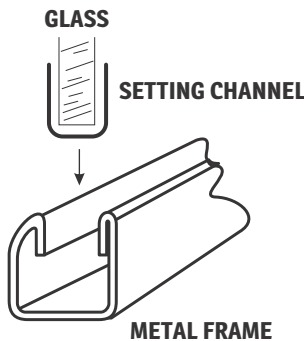

ALL SOLD PER FOOT

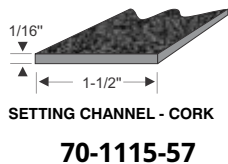
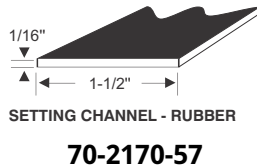



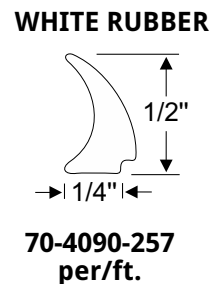
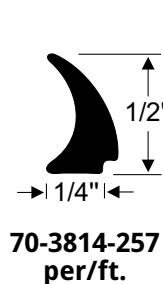

WINDOW EDGE TRIM

This rubber Window Edge Weatherstrip fills the gap between the glass and the channel to hold glass securely in place. Available in Black or White rubber.

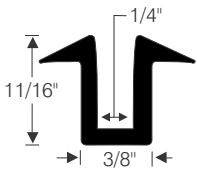
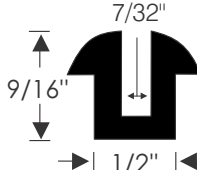
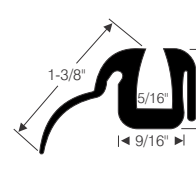
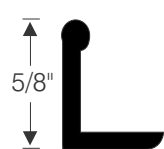
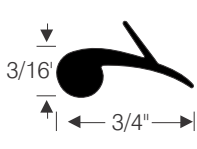
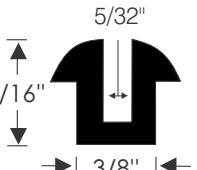
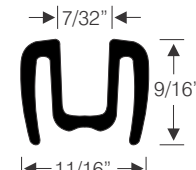

Universal Seals

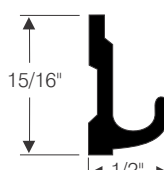
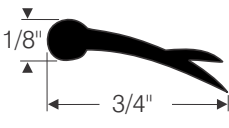
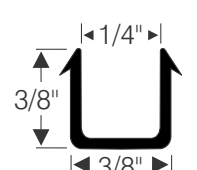
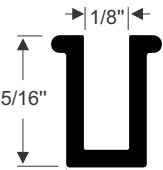
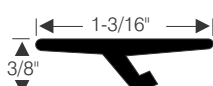
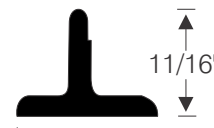
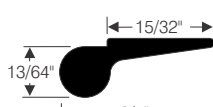
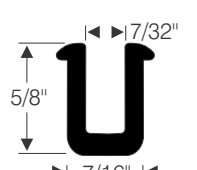
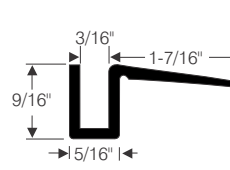
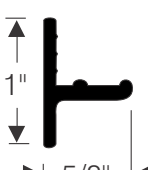

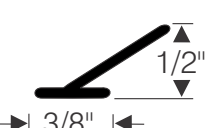
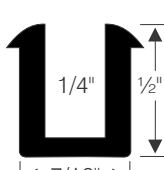
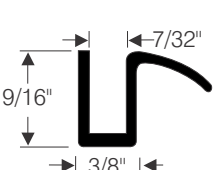
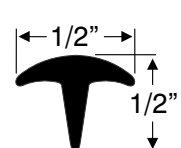
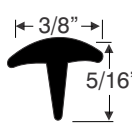
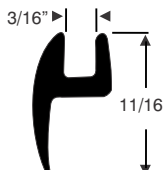
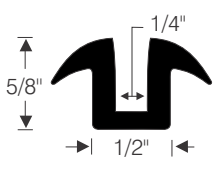
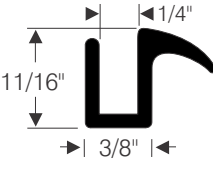
 <p>11/16" 1/4" 3/8"</p> <p>70-0241-57</p>	 <p>9/16" 7/32" 1/2"</p> <p>70-0018-99</p>	 <p>1-3/8" 5/16" 11/16" 9/16"</p> <p>70-2093-99</p>	 <p>5/8"</p> <p>11-0010-57</p>	 <p>3/16" 3/4"</p> <p>70-0997-99</p>
 <p>7/16" 5/32" 3/8"</p> <p>70-2324-57</p>	 <p>7/32" 9/16" 11/16"</p> <p>70-2844-57</p>	 <p>1-1/16" 1/2"</p> <p>30-0035-65</p>	 <p>15/16" 1/2"</p> <p>40-0095-99</p>	 <p>1/8" 3/4"</p> <p>70-1167-99</p>
 <p>3/8" 1/4" 3/8"</p> <p>70-2642-57</p>	 <p>1/8" 5/16" 1/4"</p> <p>70-3827-99</p>	 <p>1-3/16" 3/8"</p> <p>19-0004-52</p>	 <p>11/16" 1"</p> <p>70-0060-65</p>	 <p>15/32" 13/64" 3/4"</p> <p>60-0566-99</p>
 <p>7/32" 5/8" 7/16"</p> <p>30-0507-57</p>	 <p>3/16" 1-7/16" 9/16" 5/16"</p> <p>70-0489-58</p>	 <p>1" 5/8"</p> <p>50-0528-62</p>	 <p>5/8" 1-7/16"</p> <p>70-0081-67</p>	 <p>1/2" 3/8"</p> <p>70-0065-73</p>
 <p>1/4" 1/2" 7/16"</p> <p>30-0154-57</p>	 <p>7/32" 9/16" 3/8"</p> <p>60-0059-83</p>	<p>Designed to be used on glass that is flush-mounted with butyl, rivets, etc. May require trimming the stem of the "T" shape to match depth needed.</p>  <p>1/2" 1/2"</p> <p>70-4155-99 • per/ft.</p>  <p>3/8" 5/16"</p> <p>70-2841-99 • per/ft. 70-2851-52 • 12ft. 70-2850-52 • 20ft.</p>		<p>Excellent choice for universal glass setting</p>  <p>3/16" 11/16"</p> <p>70-2860-99 • per/ft. 70-2860-52 • 15ft.</p>
 <p>1/4" 5/8" 1/2"</p> <p>70-1193-99</p>	 <p>1/4" 11/16" 3/8"</p> <p>70-0075-57</p>			

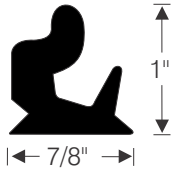

70-0288-99

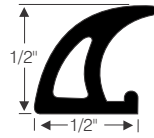

30-0084-99

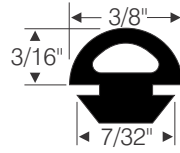

30-0139-73

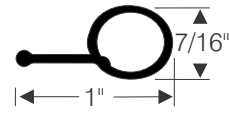

70-0116-99

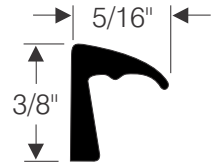

70-0079-58

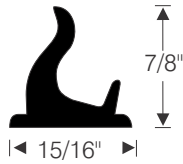

70-0251-65

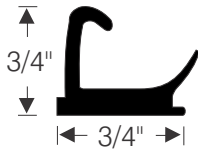

70-0155-65

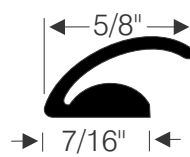

60-0047-99

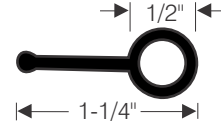

60-0054-99

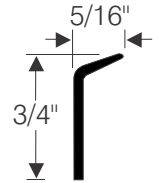

70-0064-57

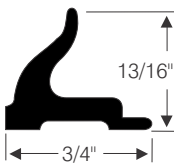

30-0031-99

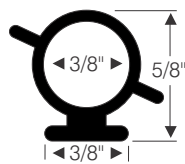

30-0051-99

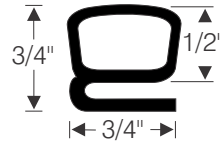

70-0236-73

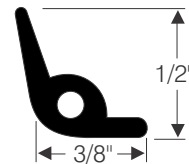

70-0231-85

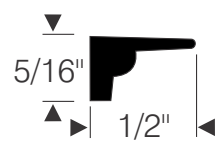

70-0585-58

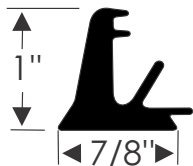

70-0570-99

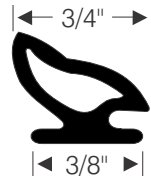

30-0085-99

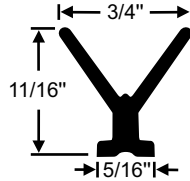

70-3960-99



50-0541-37

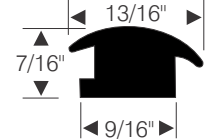

20-0102-45

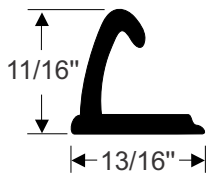

70-1171-99

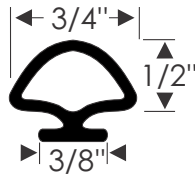

70-0066-73

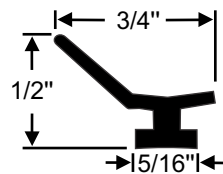

70-3996-99

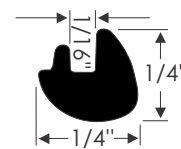

70-2166-99

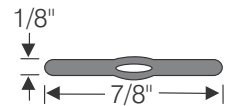

LACING - FABRIC

60-0578-42

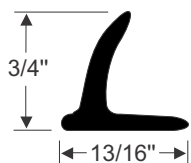

70-1170-99

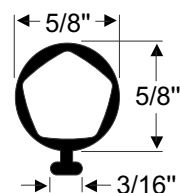

70-3795-99

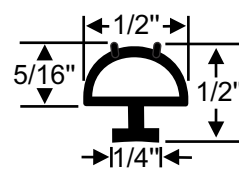

70-3999-99

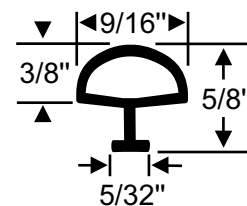

70-4067-99

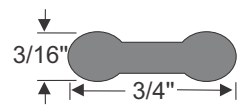

LACING - FABRIC

70-2221-42

Universal Seals



Call or visit our website for current pricing

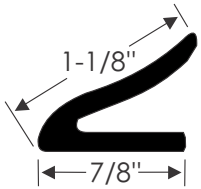

70-1446-99



70-0019-52

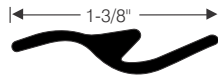

40-0487-73

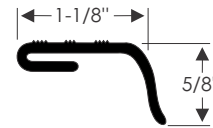

70-1448-73

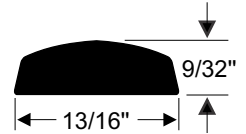

70-4639-99



60-0078-99

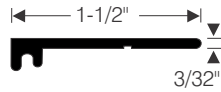

60-0055-52

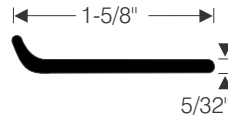

70-1237-48

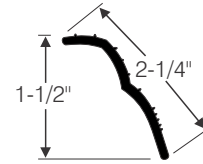

60-0660-45

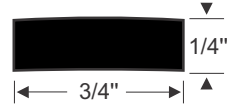

70-2424-99



70-0140-99

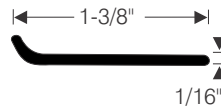

70-1236-48

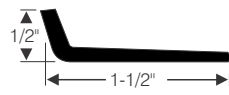

60-0667-45

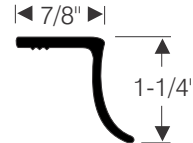

27-0106-30

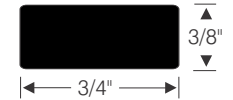

70-2423-99

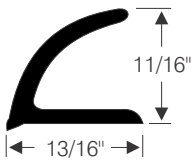

40-0475-42

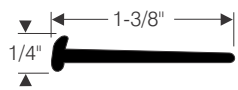

70-0308-17

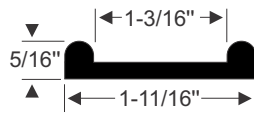

30-0482-41

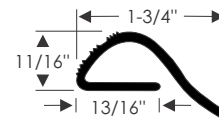

70-1292-73

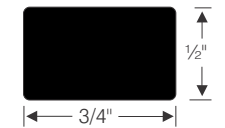

70-2422-99

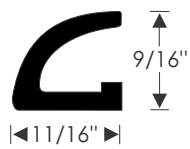

60-0153-99

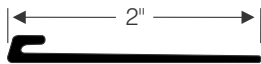

70-1693-57

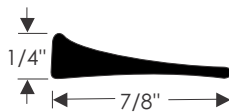

60-0287-99

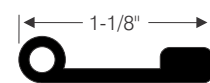

70-1656-99

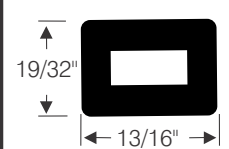

70-2396-99

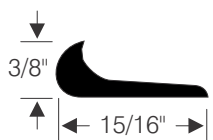

12-0010-99

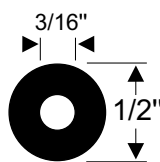

70-4064-99



60-0653-99

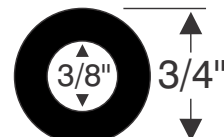

70-3976-99

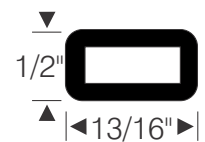

70-1583-99

SPONGE RUBBER SEALS

DENSE RUBBER SEALS ON PAGE 2

How To Order

All of our universal seals, on pages 2-13, are sold "by the foot". Simply let us know how many feet you require, and we will cut to your custom length.



Possible Uses:

Many of the seals on these pages are perfect for sealing doors and windows.

<p>70-1789-99</p>	<p>70-0492-73</p>	<p>70-1244-73</p>	<p>70-0653-99</p>	<p>70-1269-99</p>
<p>50-0085-73</p>	<p>70-0219-73</p>	<p>70-1111-73</p>	<p>70-0491-73</p>	<p>70-2705-99</p>
<p>70-0145-73</p>	<p>70-0331-73</p>	<p>70-1112-73</p>	<p>60-0456-99</p>	<p>60-0411-85</p>
<p>40-0480-73</p>	<p>30-0470-99</p>	<p>70-1045-99</p>	<p>70-3371-99</p>	<p>20-1389-99</p>
<p>70-0390-73</p>	<p>70-1267-99</p>	<p>70-1245-73</p>	<p>20-2618-99</p>	<p>60-0562-99</p>
<p>60-0416-99</p>	<p>70-0311-73</p>	<p>70-1731-99</p>	<p>20-0042-99</p>	<p>40-0168-73</p>

Universal Seals









Call or visit our website for current pricing

<p>50-0219-99</p>	<p>70-2989-99</p>	<p>70-1750-99</p>	<p>20-0302-99</p>	<p>70-3155-99</p>
<p>70-0411-73</p>	<p>70-2124-99</p>	<p>70-3228-99</p>	<p>70-2727-99</p>	<p>70-3154-99</p>
<p>60-0114-99</p>	<p>60-0732-99</p>	<p>70-1776-99</p>	<p>70-2992-99</p>	<p>70-3647-99</p>
<p>70-1258-99</p>	<p>70-1662-99</p>	<p>40-0490-99</p>	<p>70-2329-99</p>	<p>82-0216-99</p>
<p>60-0731-99</p>	<p>40-0513-85</p>	<p>70-1085-99</p>	<p>70-1663-99</p>	<p>70-0598-99</p>
<p>70-3680-99</p>	<p>70-0654-99</p>	<p>50-0340-99</p>	<p>70-0906-99</p>	<p>70-3658-99</p>

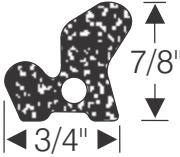
toll free 800-230-5871 • steelrubber.com

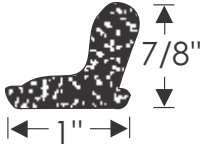
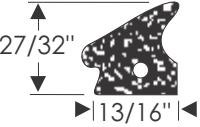
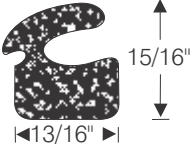
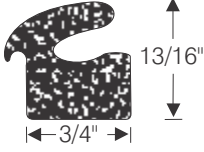
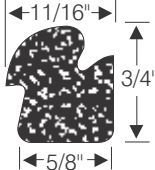
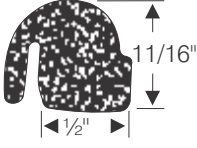
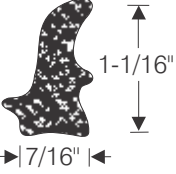
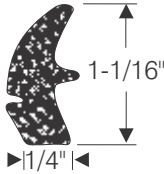
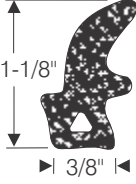
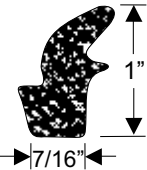
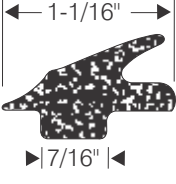
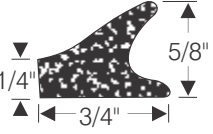
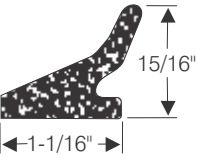
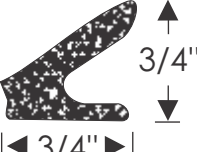
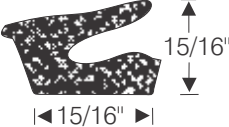
Call or visit our website for current pricing

 <p>60-0695-99</p>	 <p>70-0839-99</p>	 <p>70-0586-99</p>	 <p>70-2393-99</p>	 <p>70-2394-99</p>
 <p>70-0509-99</p>	 <p>50-0161-85</p>	 <p>70-0412-85</p>	 <p>30-0356-85</p>	 <p>20-1688-99</p>
 <p>70-0346-85</p>	 <p>70-0650-85</p>	 <p>82-0030-99</p>	 <p>70-0510-85</p>	 <p>40-0479-85</p>
 <p>70-1437-99</p>	 <p>60-0651-99</p>	 <p>70-2401-99</p>	 <p>70-0490-85</p>	 <p>70-3113-99</p>



Weatherstripping & Rubber Parts







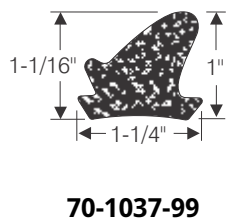











Call today for your **FREE Custom Catalog**
Specific to your year/make/model



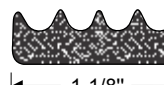

Universal Seals

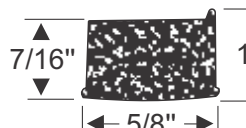

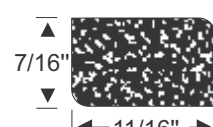
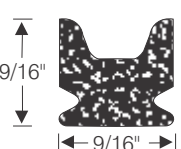
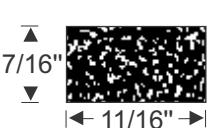
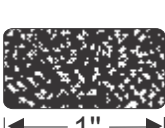
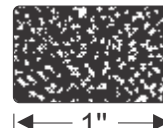
 <p>70-4684-99</p>	 <p>70-0884-99</p>	 <p>70-0957-99</p>	 <p>70-4539-99</p>	 <p>70-4540-99</p>
 <p>70-1035-99</p>	 <p>70-0518-85</p>	 <p>70-3703-99</p>	 <p>70-4541-99</p>	 <p>70-4542-99</p>
 <p>70-0463-85</p>	 <p>20-0390-99</p>	 <p>70-4497-99</p>		 <p>70-4798-99</p>
 <p>70-0701-99</p>	<div style="text-align: center;">  <p>30-0144-87</p> </div>			
 <p>70-0777-99</p>	<div style="text-align: center;">  <p>30-0243-73</p> </div>			
 <p>40-0280-57</p>	<div style="text-align: center;">  <p>70-1105-99</p> </div>			
 <p>70-1106-99</p>	<div style="text-align: center;">  <p>70-0129-99</p> </div>			

ASK ABOUT OUR NEW STREET ROD CATALOG!



Call for more information
or visit us online to see
all of our Street Rod products . . .

steelerubber.com/street-rod-parts

toll free 800-230-5871 • steelerubber.com

EDGING SEALS

These "U-Shaped" Seals can be used for covering rough or dangerous edges. These work great on Metal, Plastic or Fiberglass.

DENSE RUBBER EDGING

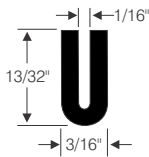

70-3167-33 • 10ft.
70-3168-33 • 15ft.
70-3166-99 • per/ft.

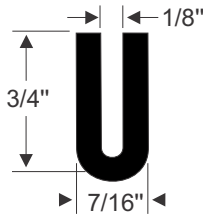

70-3888-99

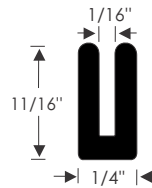

70-0077-99

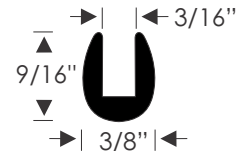

70-3247-44 • 10ft.
70-3248-44 • 15ft.
70-3246-99 • per/ft.

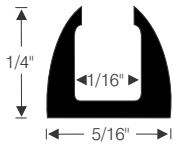

50-0100-99

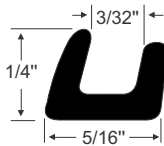

27-0090-14

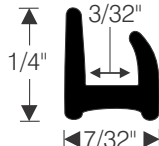

60-0685-99

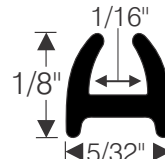

70-0836-99

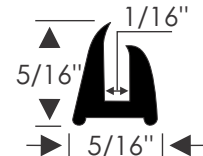

70-2856-99

SPONGE RUBBER EDGING

70-2119-99 • per/ft.
83-0120-73 • 10ft.
83-0121-73 • 15ft.

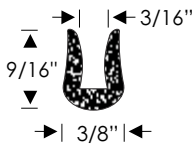

70-2118-99 • per/ft.
83-0115-73 • 10ft.
83-0116-73 • 15ft.

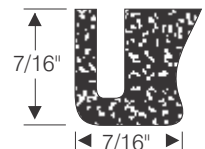
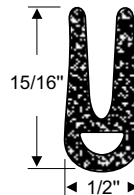

40-0162-99

EDGING WITH FLEXIBLE METAL CORE



The flexible metal cores can bend to grip edges tightly, providing a simple and safe way to seal.

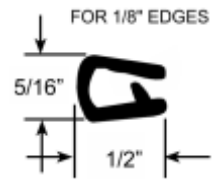

70-3601-99 • per/ft.

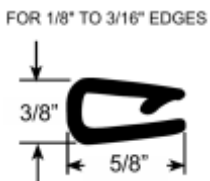

70-3600-99 • per/ft.

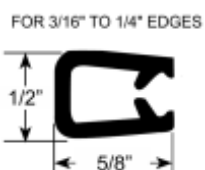

70-3598-99 • per/ft.

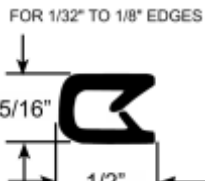

70-3602-99 • per/ft.

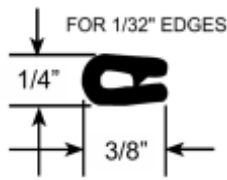

70-3597-99 • per/ft.

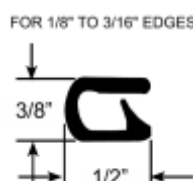

70-3599-99 • per/ft.

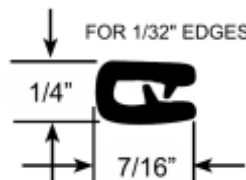

70-3596-99 • per/ft.

**- MARINE DOCK EDGING -
- UNIVERSAL HEAVY DUTY EDGING -**

Designed by Steele Rubber Products as a superior Marine Dock edging option, but also useful in other applications. Made from non-marring 80 durometer EPDM WHITE rubber

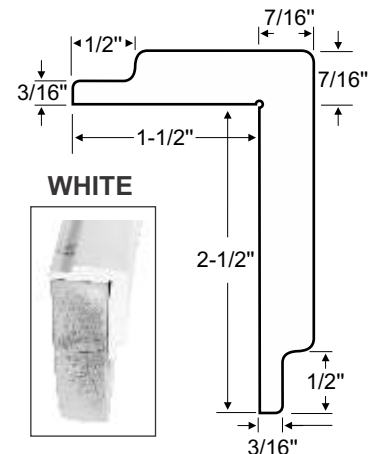

70-4767-383 • 6 ft. Strip

Call or visit our website for current pricing

PEEL-N-STICK SEALS

ALL EXTRUSIONS ON THIS PAGE ARE SPONGE RUBBER UNLESS NOTED

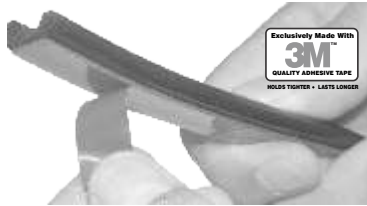

No messy glue, Just peel and stick!

Our Peel-N-Stick weatherstripping can be used any place a rubber seal is needed. With easy to use Peel-N-Stick adhesive backing, simply cut to size and fit to the areas you need to seal. Available in multiple lengths and a variety of extrusions, our Peel-N-Stick parts are made of the same quality sponge & dense rubber found in our standard rubber parts and weatherstripping.

<p>70-2084-99-WT • per/ft. 83-0102-73 • 5ft. 83-0103-73 • 10ft. 83-0124-73 • 15ft. 83-1016-73 • 30ft.</p>	<p>70-2117-99-WT • per/ft. 83-0104-73 • 5ft. 83-0105-73 • 10ft. 83-0106-73 • 15ft. 83-1017-73 • 30ft.</p>	<p>70-2087-99-WT • per/ft. 83-0127-73 • 5ft. 83-0113-73 • 10ft. 83-0114-73 • 15ft. 83-1018-73 • 30ft.</p>	
<p>70-3848-99-WT • per/ft. 70-3478-73 • 10ft. 70-3479-73 • 15ft.</p>	<p>70-3859-99-WT • per/ft. 70-3480-73 • 10ft. 70-3481-73 • 15ft.</p>	<p>70-2085-99-WT • per/ft. 83-0107-73 • 5ft. 83-0108-73 • 10ft. 83-0130-73 • 15ft. 83-1019-73 • 30ft.</p>	
<p>70-0518-85-WT • per/ft. 83-1023-85 • 5ft. 83-1024-85 • 10ft. 83-1025-85 • 15ft. 83-1026-85 • 30ft.</p>	<p>70-3677-99-WT • per/ft. 83-1049-73 • 5ft. 83-1050-73 • 10ft. 83-1051-73 • 30ft.</p>	<p>WHITE RUBBER</p> <p>70-3970-99 • per/ft. 90-3509-73 • 15ft. 90-3510-73 • 30ft.</p>	
<p>70-3850-99-WT • per/ft. 90-3511-73 • 15ft. 90-3512-73 • 30ft.</p>	<p>70-3847-99-WT • per/ft. 90-3460-73 • 15ft. 90-3461-73 • 30ft.</p>	<p>70-3802-99-WT • per/ft. 90-3462-73 • 15ft. 90-3463-73 • 30ft.</p>	<p>70-3984-99-WT • per/ft. 90-3464-73 • 15ft. 90-3465-73 • 30ft.</p>
<p>70-2088-99-WT • per/ft. 83-0128-73 • 5ft. 83-0129-73 • 10ft. 83-0119-73 • 15ft. 83-1022-73 • 30ft.</p>	<p>70-2132-99-WT • per/ft. 83-0125-73 • 5ft. 83-0126-73 • 10ft. 83-0122-73 • 15ft. 83-1021-73 • 30ft.</p>	<p>70-3852-99-WT • per/ft. 90-3531-73 • 15ft. 90-3532-73 • 30ft.</p>	
<p>70-3974-99-WT • per/ft.</p>	<p>70-3972-272 • per/ft.</p>	<p>70-3975-99-WT • per/ft.</p>	<p>SPONGE RUBBER</p> <p>70-2684-42 • 10ft. 70-2685-42 • 15ft.</p> <p>DENSE RUBBER</p> <p>70-2674-42 • 10ft. 70-2675-42 • 15ft.</p>

**MORE
PEEL-N-STICK
SEALS**

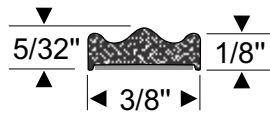

70-4624-99-WT • per/ft.

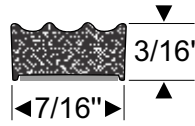

70-3846-99-WT • per/ft.
90-3466-73 • 15ft.
90-3467-73 • 30ft.

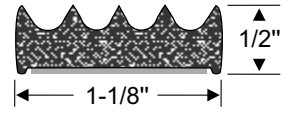

70-4798-99-WT • per/ft.

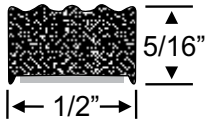

70-3672-99-WT • per/ft.
83-1037-73 • 5ft.
83-1038-73 • 10ft.
83-1039-73 • 30ft.

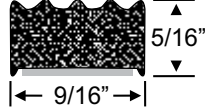

70-3673-99-WT • per/ft.
83-1040-73 • 5ft.
83-1041-73 • 10ft.
83-1042-73 • 30ft.

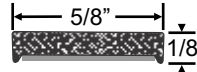

70-4205-99-WT • per/ft.
70-4307-73 • 20ft.

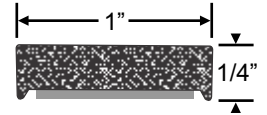

70-4204-99-WT • per/ft.
70-4306-73 • 12ft.

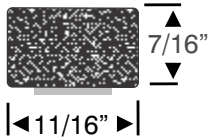

70-1105-99-WT • per/ft.
83-1033-73 • 10ft.
83-1034-73 • 30ft.

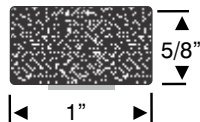

70-0129-99-WT • per/ft.
83-1031-73 • 10ft.
83-1032-73 • 30ft.

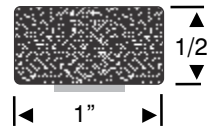

70-1106-99-WT • per/ft.
83-1035-73 • 10ft.
83-1036-73 • 30ft.

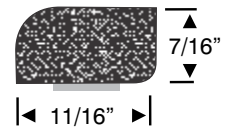

30-0243-73-WT • per/ft.
83-1029-73 • 10ft.
83-1030-73 • 30ft.

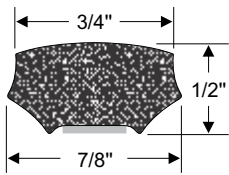

70-4770-340 • per/ft.
90-3644-340 • 15ft.
90-3645-340 • 30ft.

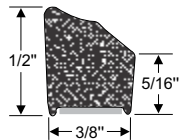

70-4756-99-WT • per/ft.

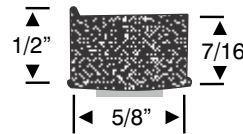

30-0144-87-WT • per/ft.
83-1027-73 • 10ft.
83-1028-73 • 30ft.

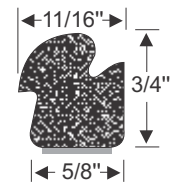

30-0356-WT • per/ft.

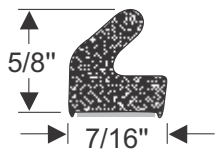

40-0480-73-WT • per/ft.
90-3472-73 • 15ft.
90-3473-73 • 30ft.

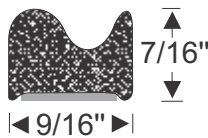

70-0390-WT • per/ft.

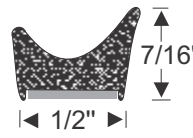

70-0331-WT • per/ft.

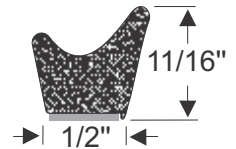

70-0145-WT • per/ft.

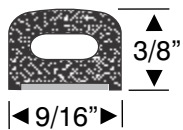

70-2086-99-WT • per/ft.
83-0109-73 • 5ft.
83-0110-73 • 10ft.
83-0111-73 • 15ft.
83-1020-73 • 30ft.

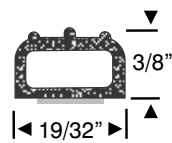

70-3676-99-WT • per/ft.
83-1046-73 • 5ft.
83-1047-73 • 10ft.
83-1048-73 • 30ft.

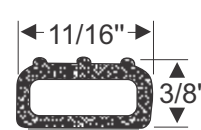

70-3849-99-WT • per/ft.
90-3513-73 • 15ft.
90-3514-73 • 30ft.

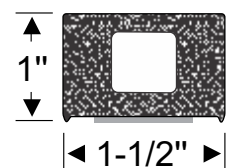

70-3872-99-WT • per/ft.
90-3468-73 • 15ft.
90-3469-73 • 30ft.

Universal Seals

**MORE
PEEL-N-STICK
SEALS**

Our Peel-N-Stick weatherstripping can be used any place a rubber seal is needed. With easy to use Peel-N-Stick adhesive backing, simply cut to size and fit to the areas you need to seal. Available in multiple lengths and a variety of extrusions, our Peel-N-Stick parts are made of the same quality sponge & dense rubber found in our standard rubber parts and weatherstripping.

Call or visit our website for current pricing

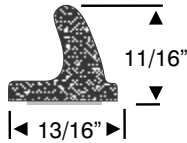

83-0135-73
10ft.

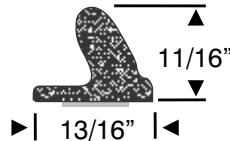

83-0131-73 • 5ft.
83-0132-73 • 10ft.
83-0100-73 • 15ft.
83-0118-73 • 30ft.



83-0134-73
10ft.

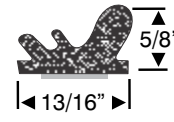

83-0136-73
10ft.

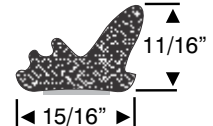

83-0140-73
10ft.

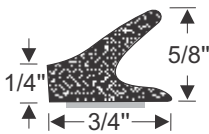

83-0137-73
10ft.
70-1437-99-WT
per/ft.

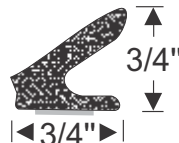

83-0139-73
10ft.
70-2401-99-WT
per/ft.

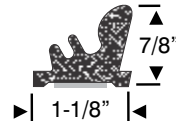

83-0133-73
10ft.



83-0138-73
10ft.

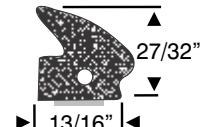

83-0123-73
10ft.

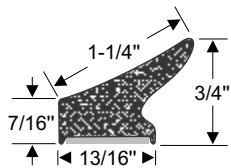

70-4504-99-WT • per/ft.

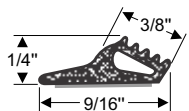

70-3858-99-WT • per/ft.

DOUBLE BULB RUBBER SEALS

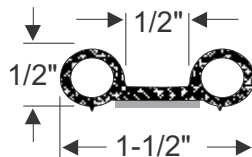

70-3897-99-WT • per/ft.
90-3519-73 • 15ft.
90-3520-73 • 30ft.

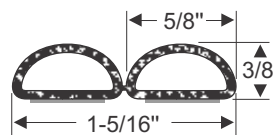

70-4057-99-WT • per/ft.
90-3521-73 • 15ft.
90-3522-73 • 30ft.

DENSE RUBBER SEALS WITH WIPER BLADE

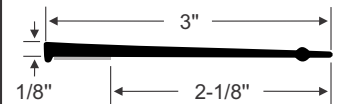

70-3709-99-WT • per/ft.

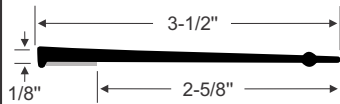

70-3856-99-WT • per/ft.

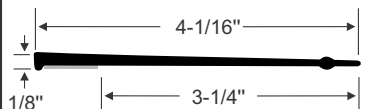

70-3899-99-WT • per/ft.

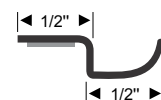

70-3973-99-WT • per/ft.

SINGLE BULB RUBBER SEALS

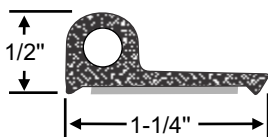

70-3708-99-WT • per/ft.
90-3533-73 • 15ft.
90-3534-73 • 30ft.

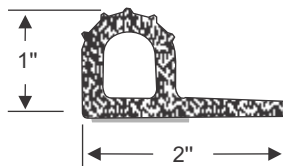

70-4186-265 • per/ft.
90-3725-265 • 30ft.

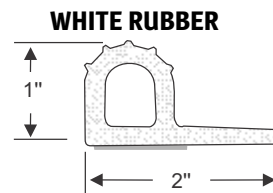

70-3711-265 • per/ft.
90-3715-265 • 30ft.

PUSH-ON SEALS

SIDE CHANNEL BULB

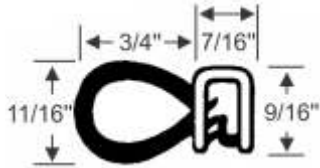

Fits flanges 1/16" to 1/8"
70-3582-99 • per/ft.



Fits flanges 3/16" to 1/4"
70-3594-99 • 25ft. Strip

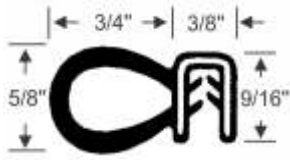

Fits flanges 3/16" to 1/4"
70-3583-99 • per/ft.

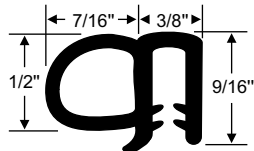

Fits flanges up to 1/8"
70-3592-99 • per/ft.



Fits flanges up to 1/8"
70-3584-99 • per/ft.

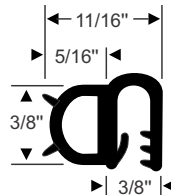

Fits flanges 3/64" to 1/8"
70-3855-99 • per/ft.

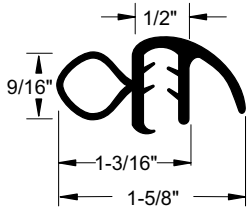

Fits 1/4" flanges
70-4144-99 • per/ft.

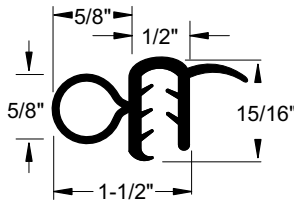

Fits flanges 1/8" to 3/16"
70-2734-99 • per/ft.

BOTTOM CHANNEL BULB

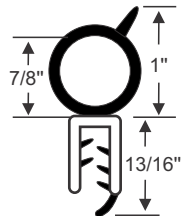

Fits flanges 7/64" to 1/8"
70-2831-99 • per/ft.



Fits flanges up to 1/8"
70-3587-99 • 25ft. Strip

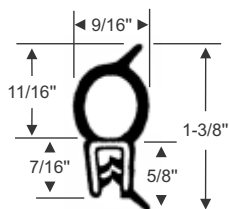

Fits flanges up to 1/16"
70-3590-99 • per/ft.

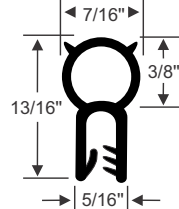

Fits flanges 3/16" to 1/4"
70-3854-99 • per/ft.

The Push-On seals on this page are made of high quality rubber. The flexible metal cores can bend to grip edges tightly, providing a simple and safe way to seal.



WITH WIPER



Fits 1/8" flanges
70-3591-99 • per/ft.

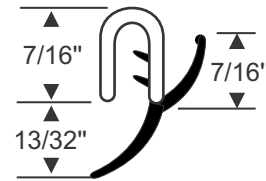

Fits 1/8" flanges
70-2746-99 • per/ft.

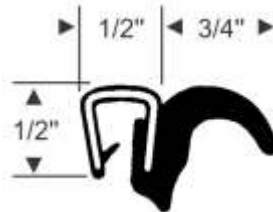

Fits flanges 3/16" to 1/4"
70-3593-99 - 25ft. Strip

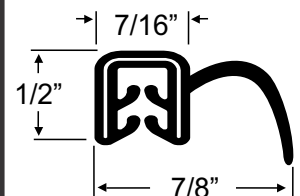

Fits flanges 1/16" to 1/8"
70-3801-99 • per/ft.

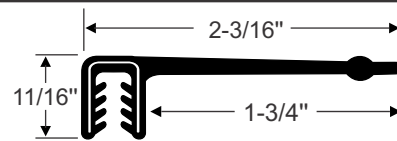

Fits flanges up to 1/8"
70-3889-99 • per/ft.

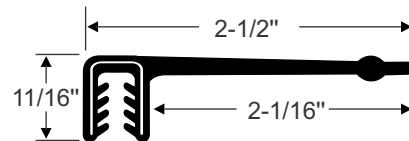

Fits flanges up to 1/8"
70-3890-99 • per/ft.

SIDE CHANNEL DOUBLE BULB



Fits flanges 3/16" to 1/4"
70-3885-99 • per/ft.

Universal Seals

RUN CHANNELS

WITH METAL SPINE



These Run Channels have a fuzzy lining which creates a smooth surface for glass to slide. They also have a metal spine which makes them tough and durable. The run channels listed here are a perfect choice when restoring antique cars.

Flexible Run Channel

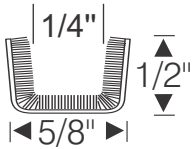

FLEXIBLE METAL SPINE
70-1107-57 - 5' strip
70-1108-57 - 6' strip

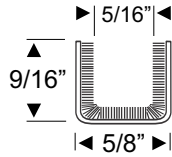

FLEXIBLE METAL SPINE
20-1619-58 - 5' strip
40-0309-57 - (2) 3' strips
40-0309-98 - 8' strip

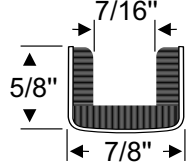

FLEXIBLE METAL SPINE
60-0375-58 - 5' strip
60-0129-58 - 90" strip

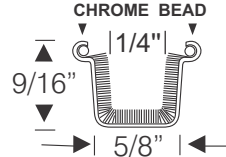

FLEXIBLE METAL SPINE
70-1238-58 - 5' strip
70-1239-58 - 6' strip

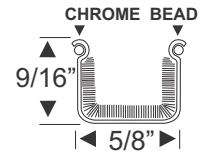

FLEXIBLE METAL SPINE
20-1146-58 - 5' strip

Rigid Run Channel

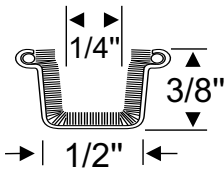

70-0536-58 - (2) 29" strips

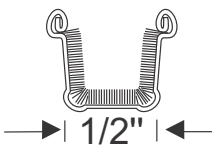

70-0516-58 - (2) 15" strips

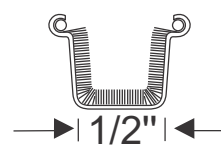

70-0347-58 - (2) 15" strips

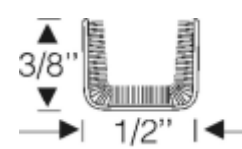

30-0023-57 - (2) 28" strips

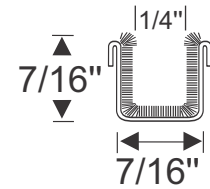

70-0752-58 - 6' strip
70-3819-58 - (2) 2' strips

Glass Sash Channel Weatherstrip

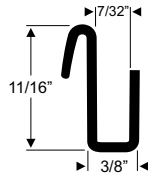

20-2091-62 - 36" Strip

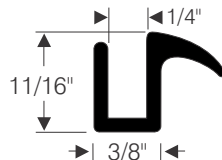

70-0075-57 - per/ft.

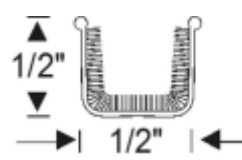

30-0180-57 - (2) 30" strips

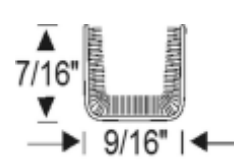

30-00245-57 - (2) 30" strips

RUBBER GLASS CHANNEL WITH FUZZY FLOCKED LINING

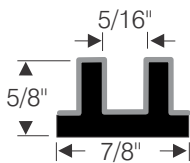

FLOCKED
70-1168-58 • per/ft

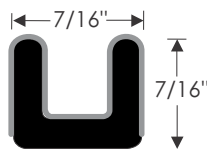

FLOCKED
70-0306-58 • per/ft

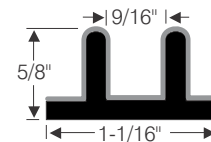

FLOCKED
70-1169-58 • per/ft

FLOCKED LINING ALSO SOLD SEPARATELY

FUZZY FINISH ON ONE SIDE
FOLD TO A "U" SHAPE FOR GLASS SETTING CHANNEL

PART#
70-2863-58 • per/ft



RUN CHANNELS

**ALL FLEXIBLE
NO METAL SPINE**

Flexible Run Channels with a flocked lining create a smooth surface for gliding window panels. Works great with glass, acrylic, fiberglass or plastic. These fibers provide low friction, flexibility and long life.

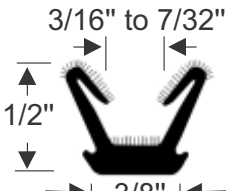
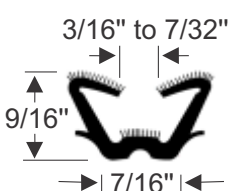
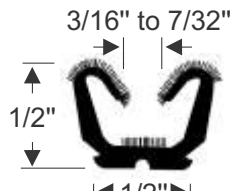
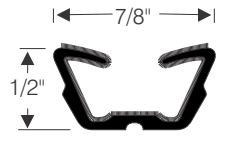
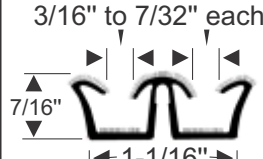
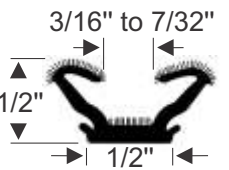
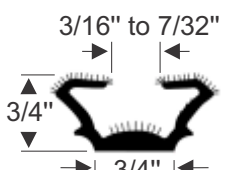
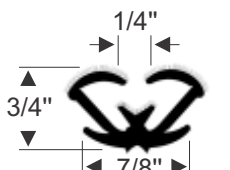
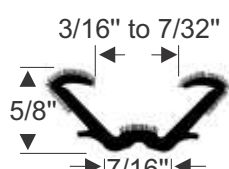
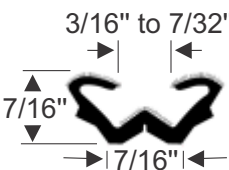
 <p>3/16" to 7/32" 1/2" 3/8" 70-3572-58 • 8' strip</p>	 <p>3/16" to 7/32" 9/16" 7/16" 70-3576-58 • 6' Strip</p>	 <p>3/16" to 7/32" 1/2" 1/2" 70-3570-58 • 8' strip</p>	 <p>7/8" 1/2" 60-0583-58 - 8' strip</p>	 <p>3/16" to 7/32" each 7/16" 1-1/16" 70-3571-58 • 8' strip</p>
 <p>3/16" to 7/32" 1/2" 1/2" 70-3575-58 • 8' strip</p>	 <p>3/16" to 7/32" 3/4" 3/4" 70-3577-58 • 8' strip</p>	 <p>1/4" 3/4" 7/8" 70-3580-58 • 8' strip</p>	 <p>3/16" to 7/32" 5/8" 7/16" 70-3578-58 • 8' strip</p>	 <p>3/16" to 7/32" 7/16" 7/16" 70-3579-58 • 8' strip</p>

BELTLINE WEATHERSTRIP

Beltline weatherstrips provide a smooth surface for glass to slide against as it rolls down into the door. They prevent glass from rattling and keep dust and moisture out of the door panel.

Call or visit our website for current pricing

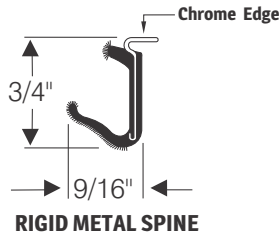

- 70-0651-58 - 5' strip
- 70-0749-60 - two 3' strips
- 70-3818-58 - two 2' strips

PEEL-N-STICK
SPONGE RUBBER
WITH FUZZY
FLOCKED COATING

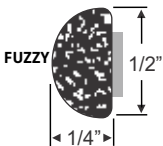

- 70-2813-60 - 5' strip
- 70-2814-60 - 10' strip
- 70-2815-60 - 15' strip

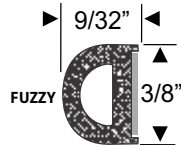

70-4062-99 - per/ft.

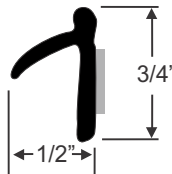

- 70-2816-60 - 5' strip
- 70-2817-60 - 10' strip
- 70-2818-60 - 15' strip

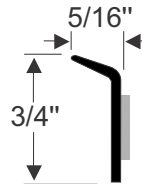

- 70-2820-60 - 5' strip
- 70-2821-60 - 10' strip
- 70-2822-60 - 15' strip

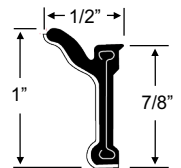

- 70-3804-61 two 4' strips

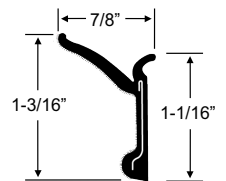

- 70-3805-61 two 4' strips

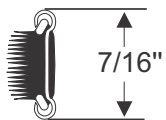

- 70-0555-58 two 3' strips
- 70-0353-78 - 6' strip

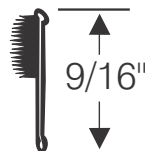

- 30-0244-57 two 3' strips

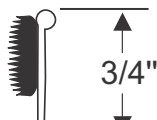

- 30-0301-57 two 3' strips
- 70-3815-57 two 2' strips

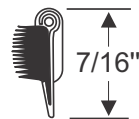

- 40-0540-57 6' strip
- 40-0539-57 two 3' strips
- 70-3817-57 two 2' strips

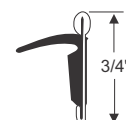

- 70-1121-61 two 3' strips
- 70-1120-61 - 6' strip

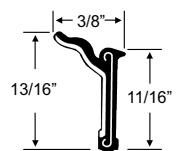

- 70-3807-61 two 4' strips

General Use Parts

ROUND GROMMETS

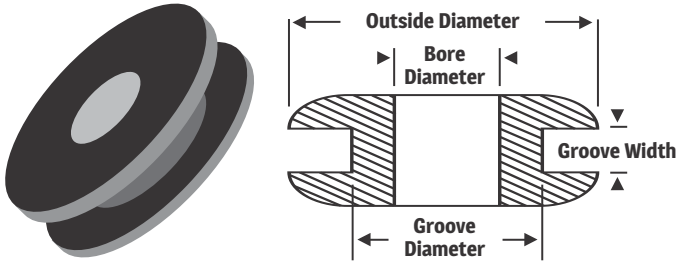

GROOVE DIAMETER = PROJECT HOLE SIZE

Part Number	GROOVE DIAMETER	Bore Diameter	Outside Diameter	Groove Width
32-1059-20	1/4"	5/32"	3/8"	1/16"
32-1060-20	1/4"	5/32"	7/16"	3/32"
32-1062-20	9/32"	5/32"	13/32"	3/32"
32-1063-20	5/16"	5/32"	7/16"	1/4"
32-1061-20	5/16"	3/16"	1/2"	1/16"
32-0352-20	3/8"	1/4"	9/16"	1/16"
32-0414-32	3/8"	5/32"	9/16"	5/32"
32-1064-20	3/8"	1/4"	1/2"	1/16"
32-1058-20	3/8"	1/8"	1/2"	3/32"
32-0514-20	3/8"	1/4"	5/8"	1/16"
32-0317-52	7/16"	1/4"	3/4"	1/16"
32-0366-53	7/16"	1/8"	5/8"	1/16"
32-1065-20	7/16"	1/4"	5/8"	1/16"
32-0537-24	7/16"	1/4"	3/4"	1/16"
32-1067-20	7/16"	5/16"	9/16"	1/16"
32-0365-20	1/2"	3/16"	3/4"	1/16"
32-0161-21	1/2"	3/8"	11/16"	1/16"
32-0132-67	1/2"	3/8"	13/16"	3/32"
32-1073-20	9/16"	7/16"	3/4"	1/16"
32-1070-20	9/16"	5/16"	13/16"	1/4"
32-0051-24	9/16"	3/8"	5/8"	5/32"
32-0491-21	9/16"	3/8"	15/16"	5/32"
32-1069-20	9/16"	5/16"	3/4"	1/8"
32-0158-17	9/16"	5/16"	13/16"	1/16"
32-1071-20	5/8"	3/8"	7/8"	1/16"
32-1072-20	5/8"	3/8"	7/8"	1/4"
32-0970-17	5/8"	7/32"	13/16"	3/32"
32-0112-20	11/16"	1/4"	1-3/16"	1/16"
32-0047-14	11/16"	3/8"	1"	1/16"
32-0165-15	11/16"	1/8"	15/16"	1/16"
32-0050-24	11/16"	15/32"	3/4"	1/4"
32-0003-21	11/16"	5/16"	1"	1/16"
32-0328-54	11/16"	3/8"	1-3/16"	1/16"
32-1068-20	3/4"	5/16"	1"	1/16"
32-0342-24	3/4"	3/8"	1"	3/16"
32-1075-20	3/4"	1/2"	1"	1/8"
32-0438-20	3/4"	1/2"	1"	3/32"
32-1074-20	3/4"	1/2"	31/32"	3/32"

Part Number	GROOVE DIAMETER	Bore Diameter	Outside Diameter	Groove Width
32-0263-17	3/4"	5/16"	1"	1/16"
32-0066-20	3/4"	1/4"	15/16"	1/16"
32-0162-21	3/4"	1/4"	15/16"	1/16"
32-0064-21	13/16"	1/4"	1"	1/16"
32-1076-20	13/16"	1/2"	1-1/16"	1/4"
32-0002-21	7/8"	13/32"	1-1/16"	1/16"
32-0224-21	7/8"	5/8"	1-1/8"	1/16"
32-1077-20	7/8"	5/8"	1-1/8"	1/8"
32-0057-24	7/8"	5/16"	1-1/4"	1/8"
32-0155-37	7/8"	1/2"	1-5/16"	1/16"
32-0364-37	29/32"	5/8"	1-1/4"	3/32"
32-1078-20	15/16"	3/4"	1-1/8"	1/16"
32-0039-14	15/16"	1/4"	1-1/4"	1/16"
32-0133-21	31/32"	3/4"	1-3/16"	3/16"
32-1066-20	31/32"	1/4"	1-7/32"	1/16"
32-0464-15	1"	3/8"	1-3/8"	1/16"
32-0714-41	1"	3/8"	1-5/16"	1/16"
32-0492-14	1"	11/16"	1-1/4"	1/16"
32-0320-21	1"	7/16"	1-7/16"	1/16"
32-0439-20	1"	7/16"	1-5/16"	1/16"
32-0390-21	1"	3/4"	1-1/4"	1/16"
32-0098-21	1"	1/4"	1-5/16"	1/16"
32-0401-45	1"	3/8"	1-1/4"	1/16"
32-0437-20	1-1/16"	7/16"	1-3/8"	1/16"
32-0253-37	1-1/16"	5/8"	2-1/16"	3/32"
32-0369-20	1-1/16"	3/4"	1-3/8"	1/16"
32-0134-20	1-1/16"	13/16"	1-5/16"	5/32"
32-1201-20	1-3/32"	9/16"	1-9/16"	3/32"
32-0167-52	1-3/32"	7/8"	1-7/16"	1/16"
32-0005-14	1-1/8"	5/8"	1-3/8"	1/16"
32-0001-37	1-1/8"	3/4"	1-9/16"	1/16"
32-0365-37	1-5/32"	5/8"	1-9/16"	3/32"
32-0062-14	1-5/32"	3/4"	1-7/16"	1/16"
32-0355-37	1-1/4"	5/8"	2"	1/16"
32-1079-20	1-1/4"	3/4"	1-5/8"	1/4"
32-0421-37	1-1/4"	3/4"	1-9/16"	1/4"
32-0422-20	1-1/4"	1/2"	1-7/16"	1/4"
32-0220-21	1-1/4"	1/4"	1-1/2"	1/16"
32-0118-37	1-1/4"	3/4"	1-5/8"	1/16"
32-0063-14	1-5/16"	1/2"	1-5/8"	1/16"
32-0455-14	1-5/16"	7/8"	1-5/8"	1/16"
32-0023-14	1-5/16"	1-1/16"	1-7/8"	1/16"
32-0196-21	1-5/16"	5/16"	1-11/16"	1/16"
32-0160-20	1-3/8"	1/2"	1-11/16"	1/8"
32-0062-20	1-3/8"	5/16"	1-7/8"	1/8"
32-0333-20	1-3/8"	7/16"	1-3/4"	3/32"
32-0225-20	1-1/2"	11/16"	2-1/4"	3/32"

STEM BUMPERS



This is a sample design. Actual stem bumpers may be different.

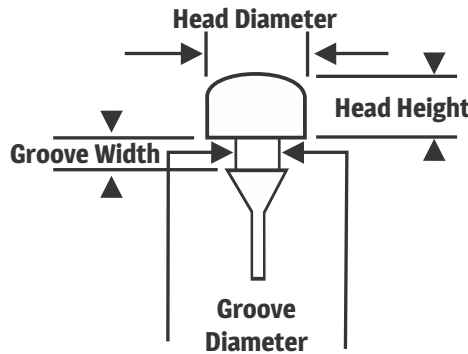

GROOVE DIAMETER = PROJECT HOLE SIZE

Our stem bumpers can be used to protect a variety of applications. Bumpers are listed below by the size of the Groove Diameter (which is the project hole size). Please call if you need assistance.

Call or visit our website for current pricing

Part Number	GROOVE DIAMETER	Head Diameter	Head Height	Groove Width
33-0730-42	1/8"	3/8"	3/32"	1/8"
33-0127-41	1/8"	5/16"	1/8"	1/16"
33-0128-88	1/8"	5/16"	1/4"	1/16"
33-0556-15	1/8"	1/2"	1/16"	7/32"
33-0348-54	3/16"	1/2"	5/8"	1/16"
33-0368-30	3/16"	1/2"	7/16"	1/8"
33-0507-62	3/16"	7/16"	1/8"	5/32"
33-0990-87	3/16"	15/16"	1/2"	1/16"
33-0117-42	3/16"	5/8"	5/16"	1/16"
33-0349-87	3/16"	1/2"	3/32"	1/16"
33-0042-42	3/16"	7/16"	1/2"	1/16"
33-0123-42	1/4"	3/4"	1/2"	1/16"
33-0512-44	1/4"	3/8"	5/32"	1/16"
33-0136-42	1/4"	1/2"	5/16"	1/16"
33-0211-31	1/4"	5/8"	1/4"	1/16"
33-0293-87	1/4"	7/8"	5/16"	1/16"
33-0459-42	1/4"	3/4"	3/16"	1/16"
33-0496-71	1/4"	1/2"	3/8"	1/16"
33-1285-42	1/4"	9/16"	3/16"	1/16"
33-0395-42	1/4"	9/16"	3/32"	1/16"

Part Number	GROOVE DIAMETER	Head Diameter	Head Height	Groove Width
33-0350-87	1/4"	15/16"	3/8"	1/16"
33-0427-42	1/4"	5/8"	3/16"	1/16"
33-0482-42	1/4"	5/8"	7/16"	1/16"
33-0046-42	1/4"	3/4"	5/16"	1/16"
33-1574-71	1/4"	5/8"	1/4"	1/16"
33-0003-42	1/4"	11/16"	1/8"	3/32"
33-0019-20	1/4"	15/32"	3/16"	1/16"
33-0449-42	1/4"	1/2"	1/4"	1/16"
60-0734-71	1/4"	9/16"	1/4"	1/16"
33-1576-71	5/16"	9/16"	1/2"	1/16"
33-1575-71	5/16"	5/8"	3/4"	1/16"
33-0531-42	5/16"	13/16"	1/4"	1/8"
33-0031-42	5/16"	1/2"	1/8"	1/16"
33-0109-71	5/16"	3/4"	1/4"	3/32"
33-0116-42	5/16"	3/4"	7/16"	3/32"
33-0542-42	5/16"	3/4"	5/16"	1/16"
33-0113-42	5/16"	3/4"	3/16"	1/16"
33-0293-71	5/16"	3/4"	11/16"	1/16"
33-0016-45	3/8"	1"	11/32"	1/16"
33-0169-42	3/8"	11/16"	3/8"	1/16"

Stem bumpers come in a variety of shapes. These are examples of different stem bumpers.



Part# 33-0127-41



Part# 33-0348-54



Part# 33-0211-31

ROUND BODY PLUGS

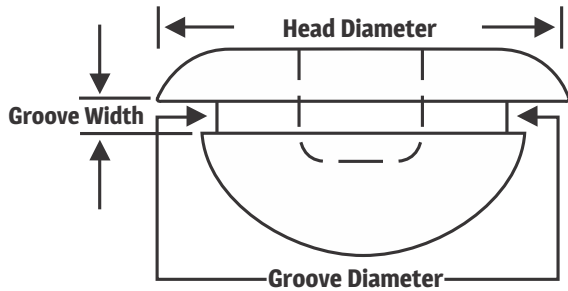

Our body plugs can be used for a variety of applications. Body Plugs are listed by the size of the groove diameter. (which is the project hole size). Please call if you need assistance.

GROOVE DIAMETER = PROJECT HOLE SIZE

Part Number	GROOVE DIAMETER	Head Diameter	Material	Groove Width
35-0458-45	3/8"	5/8"	Rubber	1/8"
35-0369-20	1/2"	3/4"	Rubber	3/32"
35-0070-87	1/2"	3/4"	Rubber	1/16"
35-1052-20	1/2"	7/8"	Plastic	1/16"
35-0171-20	9/16"	13/16"	Rubber	None*
35-0197-31	3/4"	1-1/8"	Rubber	3/32"
35-0262-20	3/4"	1"	Rubber	1/16"
35-0515-20	3/4"	1"	Rubber	1/16"
35-1053-20	3/4"	1-1/8"	Plastic	1/16"
35-1054-20	3/4"	1-1/4"	Plastic	1/16"
35-0402-87	7/8"	1-3/32"	Rubber	1/16"
35-0099-20	15/16"	1-3/16"	Rubber	1/16"
35-1214-20	1"	1-5/16"	Rubber	1/16"
35-0457-45	1"	1-3/8"	Rubber	1/16"
35-1055-20	1"	1-3/8"	Plastic	1/16"
35-0327-45	1-1/8"	1-1/2"	Rubber	1/16"
35-1056-20	1-1/4"	1-5/8"	Plastic	1/16"
35-0517-45	1-3/8"	1-5/8"	Rubber	1/16"
35-3508-45	2"	2-7/16"	Rubber	3/32"

*Part# 35-0171-20 has NO groove



This is a sample design.

Body plugs come in a variety of sizes. These are examples of our body plugs.



Part# 32-0456-20



Part# 35-0369-20



Part# 35-1214-20

Call or visit our website for current pricing



Complete selection of weatherstripping for RV's and Enclosed Trailers!

Visit steelerubber.com for many more extrusions!

SLIDE OUT SEALS



Many more RV weatherstripping seals available!!!

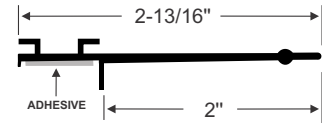

70-3883-265 • per/ft.

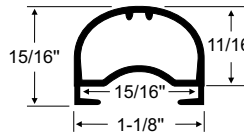

70-3882-265 • per/ft.

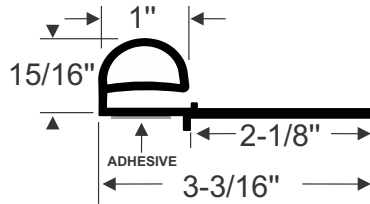

70-3800-265 • per/ft.

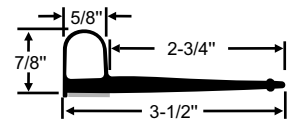

70-3712-265 • per/ft.

DOOR & COMPARTMENT

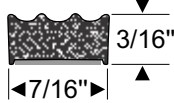

70-3846-277 • per/ft.

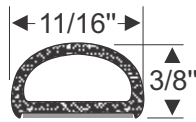

70-3848-277 • per/ft.

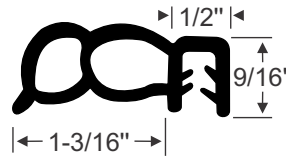

70-3885-277 • per/ft.

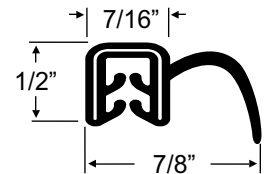

70-3801-277 • per/ft.

ROOF TOP AC/HEAT PUMP ONE PIECE GASKET

70-3905-207 • set



LEVELING BLOCKS
MAIN GASKET
DIVIDER & LEVELING BLOCKS INCLUDED

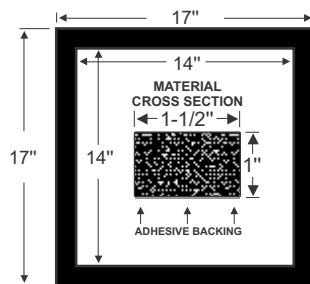

Unique 1 pc. design!

A/C GASKET PLENUM DIVIDER AVAILABLE SEPARATELY

PART# 70-4284-207

This one piece angled Plenum Divider strip is made of the same top quality materials as our A/C Gasket Kit. A high-quality one-piece divider for those RV roof-mounted A/C and

PLENUM DIVIDER



Marine Weatherstripping



NEW from Steele Rubber . . . Marine Weatherstripping!

These are just a few of our marine products.
Visit steelerubber.com today.

RUB RAIL INSERT KITS

More Profiles Available

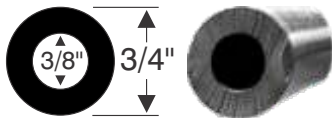

70-3976-347 - per/ft.
70-3992-347 - 50ft.
70-3993-347 - 70ft.
ALSO AVAILABLE
IN WHITE RUBBER

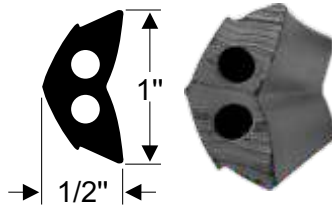

90-3331-347 - 50ft.
90-3332-347 - 70ft.
90-3333-347 - 200ft.

STEELE RUBBER PRODUCTS RUB RAIL INSERT

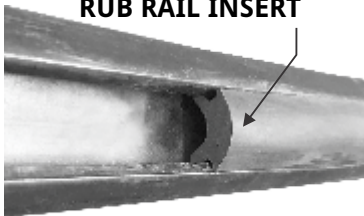

↑ COMMON RUB RAIL

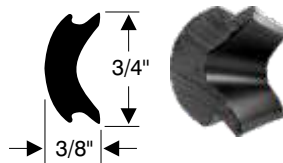

90-3338-347 - 50ft.

HATCH SEALS

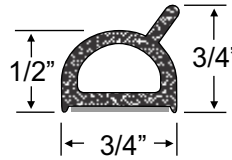

70-3984-377 • per/ft.

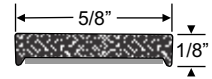

70-4205-372 • per/ft.

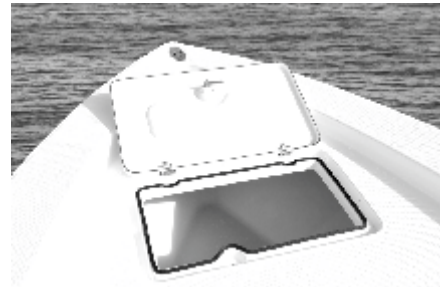

Many More Hatch Seal Profiles Available

WINDSHIELD GLASS TRIM

EXAMPLE OF WINDSHIELD
GLASS TRIM

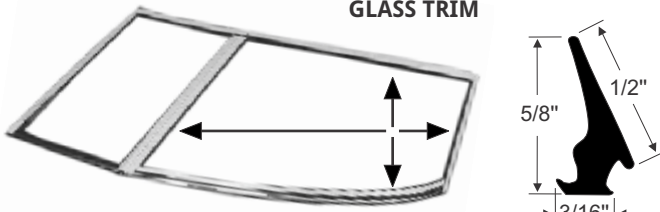

70-3794-357 • per/ft.



INSERT TRIM - SCREW COVER

FITS IN BOAT WINDSHIELD FRAMES
TO HIDE MOUNTING HARDWARE

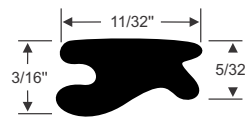

70-3825-355 • per/ft.
ALSO AVAILABLE
IN WHITE RUBBER

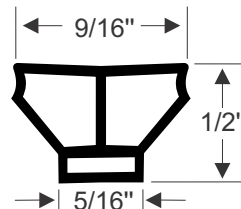

70-3813-340 • per/ft.

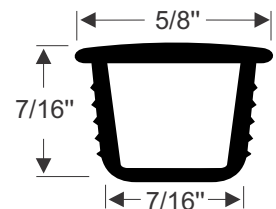

70-3824-355 • per/ft.

Many more Marine weatherstripping seals available . . .

Visit steelerubber.com today!



UNIVERSAL PARTS

This page contains parts that can be used for a variety of uses.

Dimmer Switch Grommet

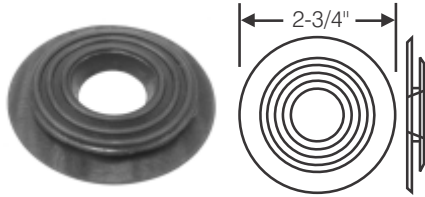

Dimmer switch grommet for automobiles. Has a wide flange for 1" hole for carpet application. 2-3/4" inches overall.

40-0083-88

Rubber Sheeting



Please order rubber sheeting by the square foot as shown here.

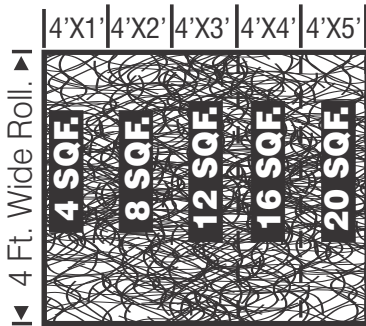

Rubber masticated sheet. 3/32" thick rubber sheet containing random milled cotton cord reinforcement. Perfect for front end automobile splash aprons. Many other uses as well. This product is four (4) foot high, and will only be sold in four (4) foot multiples (4' x 1', 4' x 2', 4' x 3', etc...). Please order by the square foot. **70-0645-45**

Fender Welting for Automobiles

Fender welting. Superior quality, proper construction of reinforced black vinyl over vinyl core. 1-3/8" inch wide. One fourth (1/4" or 3/16" bead, 25' or 50' roll. Typically used to attach fenders to automobile body.



BLACK



CHROME

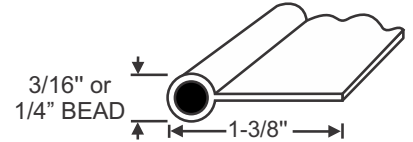

- 70-1097-44** - 1/4" bead, 25' roll.
- 70-1098-44** - 1/4" bead, 50' roll.
- 70-1099-44** - 3/16" bead, 25' roll.
- 70-1100-44** - 3/16" bead, 50' roll.
- 70-1101-44** - CHROME, 3/16" bead, 25' roll.
- 70-1102-44** - CHROME, 3/16" bead, 50' roll.

Push Button Lock Knobs



Knob or push button for inside door lock, fits over 1/8" steel rod to door lock. Hard brown rubber, may be lacquered other colors as required. OEM for many GM cars but can be used for other vehicles. **70-0660-70**



Knob or push button for inside door lock, fits over 1/8" steel rod to door lock. Neutral brown rubber. OEM for many GM cars but can be used for other vehicles. **70-0354-70**

Battery Terminal Cover

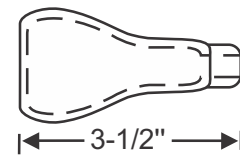

Cover, battery clamp. Control unsightly sulfate buildup. Can be used on most any vehicle battery. **70-0095-21**

Round Rubber Bushings

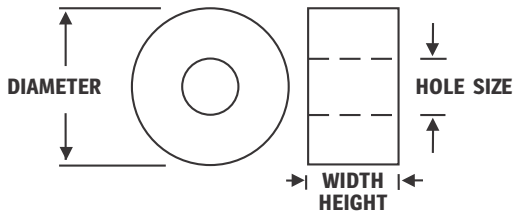

Listed by hole size

	DIAMETER	WIDTH HEIGHT	HOLE SIZE
60-0235-33	1"	11/16"	3/8"
50-0133-48	1-5/16"	3/8"	7/16"
50-0132-48	1-3/4"	5/16"	7/16"
60-0231-11	1-7/16"	7/8"	7/16"
60-0216-33	1-1/4"	3/4"	7/16"
70-1125-33	1-1/8"	1/4"	1/2"
70-1968-36	1-1/4"	5/8"	1/2"
11-0016-33	1-5/16"	11/16"	1/2"
70-0265-48	1-1/2"	1-1/4"	1/2"
70-0264-48	1-7/16"	1/4"	9/16"
70-1967-33	1-7/16"	7/8"	5/8"
11-0019-35	1-7/16"	1-1/8"	5/8"
70-2233-48	1-7/8"	9/16"	5/8"
10-0134-32	7/8"	1/4"	5/8"
50-0229-11	2-3/16"	1/2"	5/8"
60-0463-11	2-1/2"	1-1/4"	3/4"
11-0020-35	1-9/16"	1-1/8"	3/4"
50-0329-48	1-15/16"	3/4"	3/4"
50-0097-48	1-15/16"	1/2"	3/4"
50-0507-48	1-15/16"	13/16"	7/8"
60-0189-48	1-13/16"	9/16"	7/8"
70-2232-48	1-7/8"	9/16"	15/16"



Possible Uses:

Our rubber bushings and rubber pads can be used anywhere a cushion barrier is needed. Our Square/Rectangle pads are perfect for use as body mounting pads when restoring automobiles.

Square/Rectangle Rubber Pads

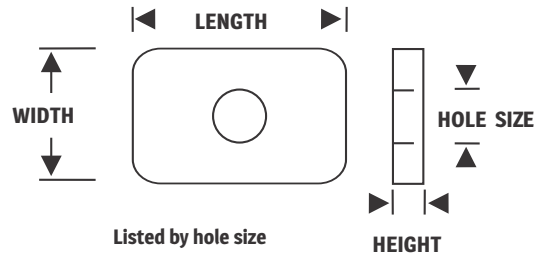

Listed by hole size

	LENGTH	WIDTH	HEIGHT	HOLE SIZE
50-0233-48	2-7/16"	1-11/16"	3/8"	1/2"
50-0231-48	3"	1-11/16"	3/8"	1/2"
50-0232-48	1-15/16"	1-15/16"	3/8"	1/2"
50-0328-48	2-1/16"	2-1/16"	7/16"	5/8"
70-2234-48	2-3/16"	2-3/16"	1/2"	3/4"
70-0634-48	3-3/16"	2-1/8"	7/16"	13/16"

Call or visit our website for current pricing

toll free 800-230-5871 • steelerubber.com

WE ALSO OFFER
Quality Crafted Rubber Parts & Weatherstripping

BUICK - OLDSMOBILE - PONTIAC - CHEVROLET - CADILLAC
 GMC TRUCK - FORD - LINCOLN - MERCURY - CHRYSLER
 PLYMOUTH - DODGE - DESOTO - AMERICAN INDEPENDENTS

"ASK ABOUT A CUSTOM CATALOG
 SPECIFIC FOR YOUR CAR OR TRUCK"

SINCE 1958

3M Masking Tape



3M™ Automotive Performance Masking Tape is a quality masking tape developed for the special requirements of the automotive restoration industry. It provides excellent adhesion to moldings, metal, plastic and rubber.

96-3433-96 - 1/2" WIDE
96-3431-96 - 3/3" WIDE

3M Super Strength Molding Tape



3M Super Strength Molding Tape is ideal for permanently attaching side moldings and trim to your vehicles, adding long-term protection and value. This tape features an extremely strong adhesive that's also easy to use. Just pull of the red liner and apply. 2 widths available.

96-3616-96 - 7/8" WIDE TAPE
96-3614-96 - 1/2" WIDE TAPE

**3M Adhesion Promoter
Sponge Applicator Packet**



Formulated specifically for use with 3M Super Strength Molding Tapes, promotes a permanent bond with most low surface energy plastic materials commonly used in interior trim and exterior trim parts.

96-6396-96

**3M Super Weatherstrip Adhesive
Black (2 oz.)***



Designed specifically to bond rubber gaskets and weatherstripping to metal surfaces. This flexible, high-strength adhesive helps ensure a tight waterproof seal on car doors, trunks, roof rails and more. Black or Yellow. 2 oz. tube.

96-8581-96 - BLACK
96-8002-96 - YELLOW

***State of California Only**  **WARNING:**

Products with an asterisk (*) can expose you to chemicals including toluene which is known to the State of California to cause cancer or birth defects or other reproductive harm. For more information, visit www.P65Warnings.ca.gov

**3M Super Weatherstrip Adhesive
Black or Yellow (5 oz.)***



This Super Weatherstrip Adhesive is designed to bond seals and gaskets to metal to ensure a waterproof and airtight seal inside your vehicle. This adhesive is ideal for weatherstripping around doors, trunk, t-tops, sunroofs, and windows. This adhesive creates a permanent bond when used on rubber, fabrics, seals, and metal. Although the adhesive remains pliable it is still resistant to the elements, detergents, grease, and more. Choice of black or yellow adhesive. 5 oz. tube.

96-8008-96 (BLACK) 96-8001-96 (YELLOW)

3M Weatherstrip Adhesive Black (5 oz.)*



This Black Weatherstrip Adhesive is designed to bond weatherstrip and seals to other rubber parts and specifically to EPDM rubber. This adhesive is ideal for door, trunk, t-top, and sunroof weatherstripping. This adhesive creates a permanent bond when used on rubber, fabrics, vinyl, and metal. Although the adhesive remains pliable it is still resistant to the elements, oil, grease, and solvents. 5 oz. tube.

96-8011-96

Loctite Super Bonder 495



General purpose instant adhesive designed to bond rubber, metal and plastic parts. Excellent for modified gaskets or rubber footage made of dense or sponge rubber. 3 gm. tube.

96-0495-96

Call or visit our website for current pricing

Black Windshield and Body Sealant



A flexible Windshield and Body Sealant designed specifically for creating a watertight seal between windshield rubber gaskets and Street Rod bodies.

96-8509-96

3M Plastic and Emblem Adhesive



An excellent clear adhesive for plastic repair and emblem application. Use this strong, quick-drying adhesive for plastic or metal emblems, interior rigid plastic, tail light lenses, vinyl side moldings or upholstery. 5 oz. tube.

96-8061-96

3M Adhesive Remover - Low VOC



3M Adhesive Remover - Low VOC is ideal for helping dissolve and remove dirt, grease, tar, and many non-curing type adhesives. Cleans without streaking and has proven to be excellent for surface preparation in adhesive applications. While this multipurpose cleaners is suitable for industrial use, it's also safe enough for everyday projects.

96-3618-96

3M Rubberized Undercoating*



3M™ Professional Grade Rubberized Undercoating produces a textured finish which resists chipping, abrasion, exterior rusting and weathering. This coating provides one-coat build-up with no dripping, running or sagging. The undercoating is excellent for automotive undercarriages and for other uses including protection for wheel wells, fenders, quarter panels and more.

96-3584-96

***State of California Only**  **WARNING:**

Products with an asterisk (*) can expose you to chemicals including toluene which is known to the State of California to cause cancer or birth defects or other reproductive harm.

For more information, visit www.P65Warnings.ca.gov

3M Urethane Adhesive*



3M™ Auto Glass Urethane Windshield Adhesive is a medium viscosity, one-part, moisture-curing urethane adhesive. It is formulated to be fast-curing and non-sagging for rapid results and a clean and simple application process. The features of this adhesive produce a high-strength bond and is ideal for mounting vehicle windshields, backlights, sidelights, and even beltline windowfelts.

96-8693-96

Ferrule installing tool



Installing tool, door and trunk handle ferrule. For 1926-1937 GM cars and trucks using door and trunk handle ferrules such as our #70-0111-69. Without it ferrules are very difficult to install and impossible to reinstall after painting. This tool, copied precisely from a Fisher Body original, does a quick, neat and efficient job of installing ferrules staking them internally to keep them in place. It is precision-machined with a hardened blade, adjusts for depth of reach, knurled for firm grip, and plated for durability. Well worth it for even one car. 6 inches long.

70-0662-69

Scraper/Tuck Tool

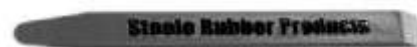

This handy tool is great for scraping off old glue and prepping surfaces without damaging metal. Also can be used to help tuck rubber which makes replacing windshield gaskets easier. A good multi purpose tool. Measures: 7-3/4" by 5/8"

94-0110-00

Heavy Duty glass retainer clip tool



This tool is specifically designed to fit trim clips over the studs and virtually eliminates glass breakage. A practical tool for placing trim retainer clips over headed studs welded around the body window shields and rear window openings.

94-0106-94

Panel Clip Retainer Removal Tool



For removing clips and retainers quickly and easily. Simply seat the tool on the shaft of the fastener and squeeze the molded handles together.

94-0100-94

Trim pad and glued in windshield molding removal tool



For auto trim work. Double ended tool combines both left and right hand. Removes reveal molding on rubberless windshield jobs. 9.5 inches long.

94-0108-94

Rope Insertion Tool



This Rope Insertion Tool is specifically designed for use when working with rubber gasket set glass. The grip handle is uniquely injects the rope through its stem as it is pulled around the gasket to install. The tool has enough durable rope to accommodate even the of largest windows.

Eighteen (18) foot rope length provides complete coverage.

94-0118-94

All purpose tool



Use to remove moldings, body clips, windshield seals, cotter pins and radiator hoses. Made of tough spring steel, heat treated, tempered and plated. 8 inches long, 4.875 inch blade with 2 inch hook.

94-0102-94

Ball End Hook Tool



This hook tool has a small, round steel ball on the end. Once the steel ball is inserted down into the rubber gasket, it is very difficult for it to come out. With the ball end design, should the tool indeed slip out of the gasket, there is less of a chance you will scratch the paint of the vehicle.

94-0101-94

Mini Hook Tool Set



This Mini Hook Tool Set offers four (4) different configurations to help you get under and pry up the smallest object.

94-0068-94

Door Panel Clip Tool



This Door Panel Clip Tool provides a quick an easy way to remove door panel clips without causing damage to the trim pad on classic collector vehicles.

94-0017-94

Steele Branded Safety Glasses



Reinforced plastic and wraparound frame.

94-0109-94

Dyna Roller Tool



This Dyna Roller Tool is made of hardwood and serves as an economical tool for applying Ultra-Mat Heat and Sound Insulator Underlayment.

96-1005-96 - 1" ROLLER 96-1007-96 - 2" ROLLER

Locking Strip Tool



The unique design of this Swivel Tip Locking Strip Tool allows the tip to swivel 90 degrees in either direction to work where other tools will not.

94-0111-94

Locking Strip Tool



This tool helps install the 3/8" locking strip used on the windshield and rear window of some cars.

94-0115-94

Rivet Set Tool



Commonly used to secure a rivet which retains weatherstrip installed into a window frame.

94-3740-94

Call or visit our website for current pricing

Vent Window Rivets and Setting Tool



This Vent Window Rivet pair and Setting Tool includes the peening punch and step rivets to replace the hinge post pivot rivet for both left and right vent window assemblies.

70-4789-70

Vent Window Rebuild Set



This Vent Window Rebuild Set includes glass setting tape (1/16"), hinge pivot step rivet pair, and a rivet peening punch. The set has enough materials for both the passenger side

and driver side vent window assemblies.

70-4801-70

Vent Window Pivot Post Rivet



Used to replace the hinge post pivot rivet for both left and right vent window assemblies. Sold as each.

70-4757-98

Weatherstrip Installation Kits

Weatherstrip General Installation Kit 90-3355-90



- 1 ea. 3M Weatherstrip Adhesive Black 96-8008-96
- 1 ea. Locktite Super Bonder 495 96-0495-96
- 1 ea. 3M Adhesive Cleaner 96-8987-96
- 1 ea. Scraper/Tuck Tool 94-0110-00
- 1 roll 1-1/2" Masking Tape 96-3431-96
- 3 pr. Nitrile Disposable Gloves
- 2 ea. Adhesive Applicator Sticks
- 1 ea. Steele Rubber Products Decal

Locking Strip Glass Installation Kit 90-3356-90



- 1 ea. Locking Strip Tool 94-0111-94
- 1 ea. Windshield/Body Sealant 96-8509-96
- 1 ea. Ball End Hook Tool 94-0101-94
- 1 ea. Scraper / Tuck Tool 94-0110-00
- 1 roll 1-1/2" Masking Tape 96-3433-96
- 3 pr. Nitrile Disposable Gloves
- 1 ea. Steele Rubber Products Decal

Rope-In Glass Installation Kit 90-3357-90



- 1 ea. Rope Insertion Tool 94-0118-94
- 1 ea. Windshield/Body Sealant 96-8509-96
- 1 ea. Ball End Hook Tool 94-0101-94
- 1 ea. Scraper/Tuck Tool 94-0110-00
- 1 roll 1-1/2" Masking Tape 96-3433-96
- 3 pr. Nitrile Disposable Gloves
- 1 ea. Steele Rubber Products Decal

VEHICLE SPECIFIC CATALOGS ALSO AVAILABLE!



Get your completely customized Steele Rubber Products Catalog!
You tell us what you're working on and we'll send you a catalog
full of parts specifically for that car or truck.
Order as many catalogs as you have projects!



toll free 800-230-5871 • steelrubber.com

CONTACT US

ONLINE - CHAT
STEELERUBBER.COM

TOLL FREE
800-230-5871

EMAIL
parts@steelerubber.com



Customer Service

Steele provides quality service both before and after your purchase. To place orders, check order status, request a catalog or for any other inquiries, contact us Mon-Friday 8am-6pm Eastern Standard Time at 800-230-5871 (toll free) or 704-483-9343 (local). You can also contact us 24/7 at contact@steelerubber.com.

Return Policy

In the event that you need to return any products, contact us directly Monday-Friday 8am-6pm at 800-461-7089 (toll free) or 704-483-9343 (local) and our Customer Service Representatives will provide you with a return merchandise authorization number (RMA) and instructions for returning any part(s) to us.

Note:

Parts are accepted for return only in the units purchased and with the original invoice. We cannot accept refund packages sent COD or any method for which there is a charge to us. If a part is altered or damaged in any way, we will not be able to accept it for return. We cannot accept returns of products not purchased directly from Steele Rubber Products. Shipping and handling charges are not refundable. To view our full return policy visit: steelerubber.com/returns

Parts Availability

New parts are constantly added to our inventory. Visit us online for current availability of all products.

Delivery of Parts

We cannot guarantee a continuous roll of any extrusion in this catalog when ordered in bulk. We will do our best to ensure that each strip is as long as possible to minimize scrappage for you. Therefore, we reserve the right to deliver your parts in multiple lengths to meet your total purchase requirements.

Use of Parts

These parts are not recommended for specific usage. We are not responsible for damages caused by incorrect installation, abuse, mishandling, accidents or normal wear. Nor will Steele be responsible for labor charges, inconveniences, or any other expenses associated with parts bought through resellers or Steele Rubber Products.

Satisfaction Guarantee:

We offer a 100% satisfaction guarantee on all parts manufactured by and purchased from Steele Rubber Products.

Copyright Section

Contents 2024© Steele Rubber Products, Inc. Printed in the USA. This catalog may not be reproduced without written permission. All drawings, photographs, and graphic images contained in this catalog are the property of Steele Rubber Products and cannot be reproduced without written permission. The contents of this catalog should not be altered in any way for commercial or other use.

Payment Information



For full disclosure of Steele Rubber Products policies please visit us online at <https://www.steelerubber.com>. If you do not have access to the internet and would like a printed version of our policies, please call 800-230-5871 (toll free) or 704-483-9343 (local).

Please visit our website for the most up-to-date product information.
toll free 800-230-5871 • steelerubber.com

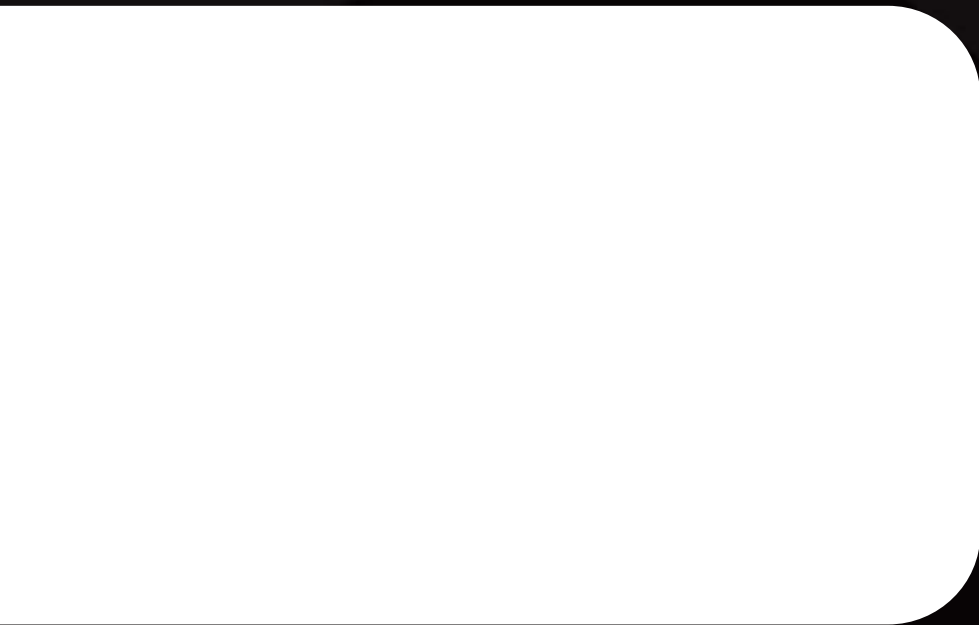

Steele
RUBBER PRODUCTS®



Steele Rubber Products
6180 E. NC 150 HWY
Denver, NC USA 28037

Toll Free 800-230-5871

REVISED
8/29/24